



Installation Guide

Philmac[®] 3G[™]

P O T A B L E W A T E R S Y S T E M S

PHILMAC[®] 3G[™] COMPRESSION FITTINGS



IPEX
by **alialxis**

Turn On To Faster Installation[™]

TABLE OF CONTENTS

PHILMAC® 3G™ NEXT GENERATION COMPRESSION FITTINGS	2
Introduction	2
Applications	2
PHILMAC 3G BENEFITS	3
CTSOD FITTINGS	5
3G Benefits	5
Materials & Components	5
Principles of Operation	6
Installation Instructions	8
Disassembly	9
Product Range & Sizes for CTSOD Fittings	10
ID SERIES FITTINGS	15
3G Benefits	15
Materials and Components	15
Principles of Operation	16
Installation Instructions	18
Product Range & Sizes for ID Series Fittings	20
CONVERSION KITS	24
Conversion Instructions	24
SYSTEM DESIGN CONSIDERATIONS	28
Projected Life of Compression Fittings	28
Head Losses	28
Resistance to Impact	29
Abrasion Resistance	29
Weathering	29
Electrolytic Corrosion	29
Thermal Insulation	29
Light Transmission	29
Effect on Water	29
Fluids other than Water	29

PHILMAC® 3G™ NEXT GENERATION COMPRESSION FITTINGS

Introduction

3G Compression fittings are the next generation of PE pipe fittings from Philmac. With its unique Slide & Tighten™ technology, no pipe preparation is needed, and no force is required to push the pipe past the seal. Made from high performance thermoplastics, they are resistant to corrosion and have the strength and durability to provide a 50+ year design life. With 3G, Philmac has created a common platform of fittings for all PE pipe applications in North America.

Applications

Residential Water Service

- New house connections
- Repair and maintenance of existing lines

Cottage Country Water Service

- Cottage water supply
- Pump systems
- Water wells

Residential Irrigation Systems

- Lawns and gardens
- Ponds
- Fountains
- Backyard waterfalls

Rural Irrigation

- Farm and agricultural water supply
- Horticultural irrigation water supply



PHILMAC 3G BENEFITS

Compact Design

The size of the Philmac 3G Compression fittings have been kept to a minimum, making the fitting ideal to use in confined areas. In addition to making connections with minimal turns of the nut, the design and size of the fittings make pipe manipulation easy in installations taking place between two fixed points.

Visual Stop

The flange on the body of the 3G compression fitting provides a visual stop to indicate when the nut is fully tightened. This removes any uncertainty from the installation process and eliminates the risk of over-tightening.

Designed to Minimize Pipe Twist

The fitting has been designed to minimize pipe twist as the nut is tightened. Maximum pipe twist is approximately a quarter turn compared to one and a half turns with many other fittings. Pipe twist can impact not only the connection you have just made, but also on the connection at the other end of the line. Pipe twist can be time consuming, especially with traditional materials such as brass fittings.



Component Interchangeability

Because both the CTSOD and ID Series fittings are based on the same core fitting design, components can be easily interchanged in order to transition from one type to another on the same fitting. And with adaptor kits available for other material types, you'll always have the right fitting for the job.

Made from Advanced Thermoplastic Materials

3G compression fittings are manufactured from lightweight high performance thermoplastic materials which, unlike metal fittings, resist corrosion, therefore significantly minimizing maintenance, repairs and long-term costs. The materials are non-toxic and taint-free and also offer outstanding impact, UV and chemical resistance.

Pressure Rating

3G compression fittings are pressure rated to 230psi to meet the needs of high pressure systems.

Design Life

Built to withstand the toughest conditions to ensure longevity and durability, 3G compression fittings have a 50+ year design life.

Complete Coverage

The new 3G compression fittings range is comprehensive; straight and reducing joiners, tees, elbows, male and female adaptors and caps ranging from 1/2" to 2".

Standards

The entire Philmac 3G range of compression fittings are CSA certified to meet NSF 61 for potable water use.



CTSOD FITTINGS

3G Benefits

Slide & Tighten™ Technology

3G compression fittings incorporate all the benefits of Philmac's unique Slide & Tighten technology. No pipe preparation is needed and no force is required to push the pipe past the seal, so installation couldn't be faster or easier. Simply insert the pipe into the fitting until the first point of resistance is felt and then tighten the nut. Assembly is so easy you can sometimes even do it under live conditions. Philmac fittings come pre-assembled and ready to use, so there is no need to disassemble the fitting on the jobsite.

Easy Disassembly

The fitting has been designed so the split collet is released as soon as the nut is backed off, which allows the pipe to be easily removed from the fitting.

Dynamic Sealing Method

The nut thread compresses the seal into position, eliminating resistance when inserting the pipe into the fitting so there is no risk of seal distortion or displacement.

Standards

PE pipe, tubing and fittings for cold-water pressure service. B137.1, CSA & NSF 61.

Materials & Components

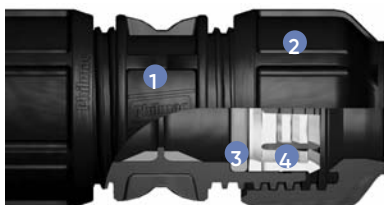

	COMPONENTS	MATERIALS
1	Body	Polypropylene
2	Nut	Acetal
3	Seal	Nitrile Rubber
4	Split Collet	Acetal

PRINCIPLES OF OPERATION

FULLY OPEN

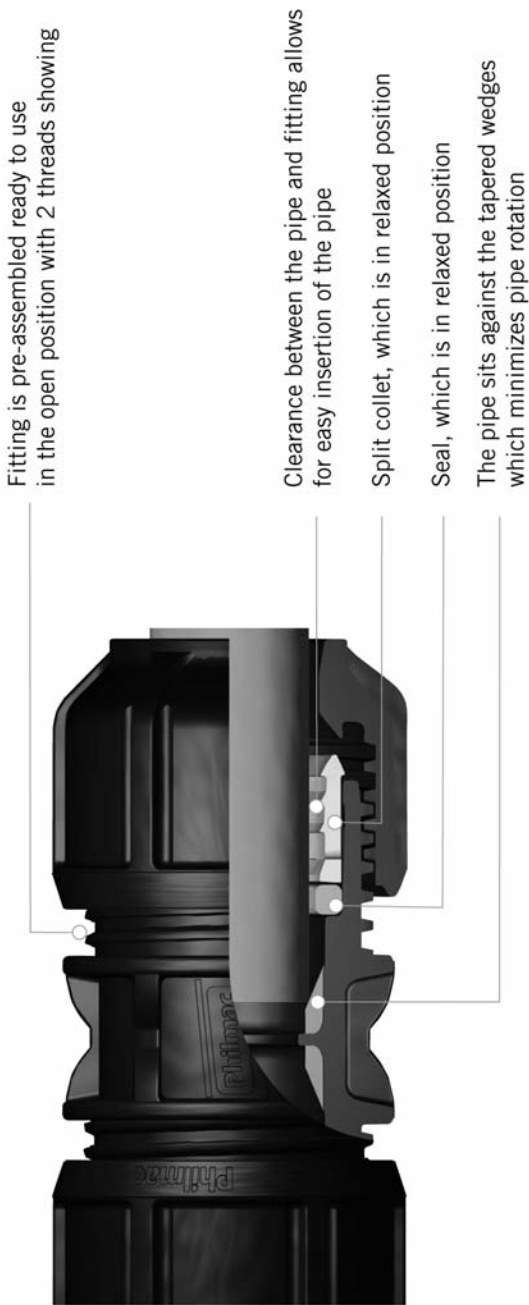

FULLY CLOSED



Split collet bites into the pipe providing end load resistance

Positive internal stop when nut meets flange of the body

Nut and then split collet has fully compressed the seal. Seal ring compression is achieved by exploiting the mechanical advantage of the nut thread

INSTALLATION INSTRUCTIONS

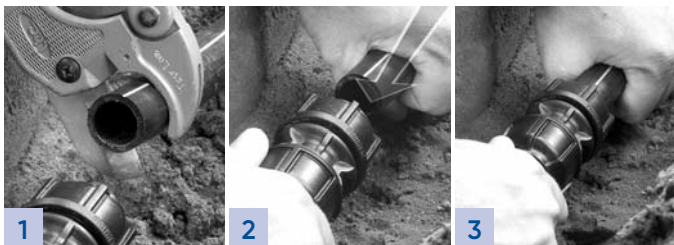

1. Cut Pipe Square

Cut the pipe square using pipe cutters. There is no need to prepare the pipe end. Chamfering or lubrication is not required.

2. Ready to Use Position

The fitting is pre-assembled and ready to use, however, always ensure the nut is fully relaxed and two threads are showing before inserting the pipe into the fitting joint.

3. Pipe Insertion

Insert the pipe into the joint until the first point of resistance is felt.



4. Nut Tightening

The nut should be tightened by hand and then firmly with a wrench. Tighten the nut all the way to the flange on the body of the fitting.

5. Fully Installed

The fitting is now fully installed.

NOTES

Care must be taken not to cut the pipe too short as it is essential to draw the pipe into the fitting when making a joint.

For sealing NPT and AWWA threads, PTFE (Teflon) tape should be applied to male threads.

Avoid excessive wrench pressure on central body when tightening nuts.

DISASSEMBLY

Philmac 3G fittings are easily disassembled by simply loosening the nut until two threads are showing. The pipe will be released and can simply be pulled out of the fitting.



PRODUCT RANGE & SIZES FOR CTSOD FITTINGS

COUPLING – COMP X COMP



Size (in)	Product Code	Package Qty.
3/4 x 3/4	258000	10
1 x 3/4	258005	10
1 x 1	258001	10
1-1/4 x 1	258131	5
1-1/2 x 1-1/2	258003	1
2 x 2	258004	1

MALE ADAPTORS – COMP X MI NPT



Size (in)	Product Code	Package Qty.
3/4 x 1/2	258006	10
3/4 x 3/4	258007	10
1 x 1/2	258008	10
1 x 3/4	258009	10
1 x 1	258010	10
1-1/4 x 3/4	258011	5
1-1/4 x 1	258012	5
1-1/4 x 1-1/4	258013	5
1-1/2 x 1	258014	1
1-1/2 x 1-1/4	258015	1
1-1/2 x 1-1/2	258016	1
2 x 1-1/2	258017	1
2 x 2	258018	1

CTSOD FITTINGS

FEMALE ADAPTORS – COMP X FI NPT



Size (in)	Product Code	Package Qty.
3/4 x 1/2	258019	10
3/4 x 3/4	258020	10
1 x 3/4	258021	10
1 x 1	258022	10
1-1/4 x 1	258023	5
1-1/4 x 1-1/4	258024	5
1-1/2 x 1-1/4	258025	1
1-1/2 x 1-1/2	258026	1
2 x 1-1/2	258027	1
2 x 2	258028	1

ELBOW – COMP X COMP



Size (in)	Product Code	Package Qty.
3/4 x 3/4	258029	10
1 x 1	258030	10
1-1/4 x 1-1/4	258031	5
1-1/2 x 1-1/2	258032	1
2 x 2	258033	1

COMP
MI NPT
FI NPT

Compression
Male Iron National Pipe Thread
Female Iron National Pipe Thread

CTSOD FITTINGS

ELBOW – COMP X FI NPT



Size (in)	Product Code	Package Qty.
3/4 x 3/4	258034	10
1 x 3/4	258035	10
1 x 1	258036	10
1-1/4 x 1	258037	5
1-1/4 x 1-1/4	258038	5
1-1/2 x 1-1/4	258039	1
1-1/2 x 1-1/2	258040	1

TEE – COMP X COMP X COMP



Size (in)	Product Code	Package Qty.
3/4 x 3/4 x 3/4	258042	10
1 x 1 x 1	258043	5
1-1/4 x 1-1/4 x 1-1/4	258044	5
1-1/2 x 1-1/2 x 1-1/2	258045	1

CTSOD FITTINGS

TEE – COMP X COMP X FI NPT



Size (in)	Product Code	Package Qty.
3/4 x 3/4 x 3/4	258047	10
1 x 1 x 3/4	258048	10
1 x 1 x 1	258049	10
1-1/4 x 1-1/4 x 3/4	258050	5
1-1/4 x 1-1/4 x 1	258051	5
1-1/4 x 1-1/4 x 1-1/4	258052	5
1-1/2 x 1-1/2 x 3/4	258053	1
1-1/2 x 1-1/2 x 1-1/4	258054	1
1-1/2 x 1-1/2 x 1-1/2	258055	1

COMP Compression
MI NPT Male Iron National Pipe Thread
FI NPT Female Iron National Pipe Thread

NOTES



ID SERIES FITTINGS

3G Benefits

Universal Fitting

The 3G ID Series compression fitting connects to all types of ID Series pipe (75, 100, 125, 160 and 200). There is no need for dedicated fittings for different pipe, so you can be sure you will always have the right fitting for the job.

Insert Assembly

Installation involving double-ended products is made easy with 3G ID Series compression fittings, as the installer can simply hammer the insert in separately to each end of the pipe.

Easy disassembly

The 3G ID Series compression fitting enables the joint to be easily disconnected and reconnected. Simply by loosening the nut and taking the insert out of the body of the fitting, the pipe can be freed. This is a real advantage when the pipe is connected to a pump or other piece of equipment which may require relocation or disconnection.

Materials and Components

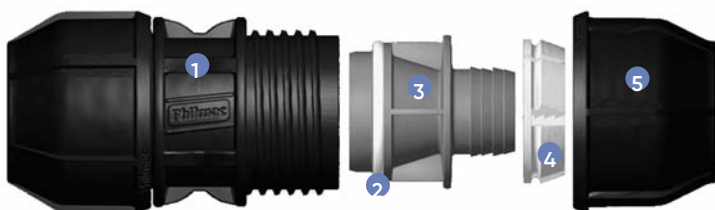

	COMPONENTS	MATERIALS
1	Body	Polypropylene
2	Seal	Nitrile Rubber
3	Insert	Nylon
4	Split Collet	Acetal
5	Nut	Acetal

PRINCIPLES OF OPERATION

FULLY OPEN

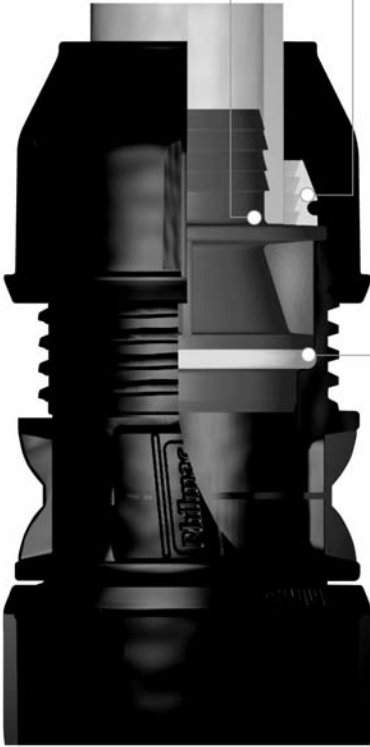

Insert fully installed into the pipe
up to the shoulder of the insert

Split collet is in the related position

Insert with seal ring attached has been
pushed back into the fitting body

FULLY CLOSED

Split collet bites into the pipe providing end load resistance

Seal ring is compressed against the inside face of the fitting to provide a seal

INSTALLATION INSTRUCTIONS

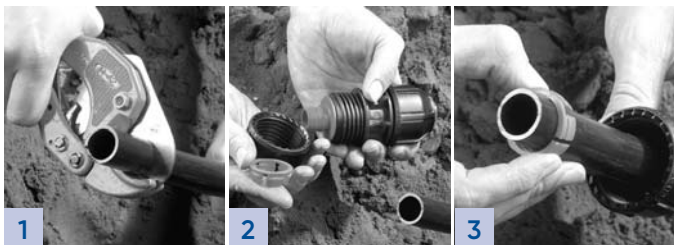

1. Cut the pipe square

Cut the pipe square using a pipe cutter. There is no need to prepare the pipe end. Chamfering or lubrication is not required.

2. Remove Nut Components

Take nut off the body of the fitting and then remove collet.

3. Place Nut Components on Pipe

Place nut and then collet on the pipe. Ensure the collet is placed with taper facing towards the nut.



4. Place Insert in Pipe

Remove the insert from the fitting and then place in end of pipe.

5. Insert Fully Installed

Tap insert fully (up to the shoulder of the insert) into the pipe using a flat object.

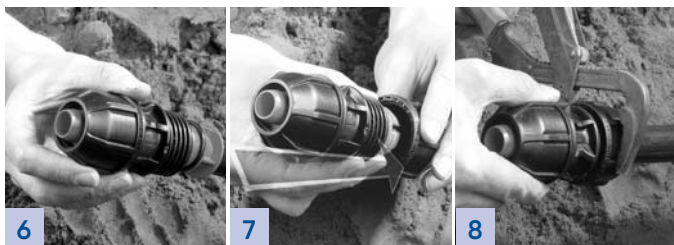

6. Push Insert into Body of Fitting

Push pipe with insert and seal ring assembly into the end of the central fitting. Ensure the seal ring is correctly positioned on the insert.

7. Position Collet and Nut

Slide collet up to insert shoulder and then engage nut on body of fitting and tighten by hand.

8. Tighten Nut with a Wrench

The nut must then be tightened with a wrench.

9. Fully Installed

The fitting is fully installed when the nut cannot be tightened further with reasonable force.

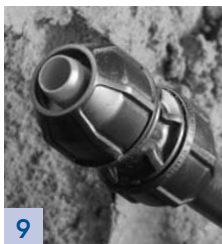

NOTES

Care must be taken not to cut the pipe too short as it is essential to draw the pipe into the fitting when making a joint.

For sealing NPT and AWWA threads, PTFE (Teflon) tape should be applied to male threads.

Avoid excessive wrench pressure on central body when tightening nuts.

PRODUCT RANGE & SIZES FOR ID SERIES FITTINGS

COUPLING – COMP X COMP



Size	Product Code	Package Qty.
1/2 x 1/2	258059	10
3/4 x 1/2	258065	10
3/4 x 3/4	258060	10
1 x 1	258061	5
1 1/4 x 1 1/4	258062	1
1 1/2 x 1 1/2	258063	1
2 x 2	258064	1

MALE ADAPTORS – COMP X MI NPT



Size (in)	Product Code	Package Qty.
1/2 x 1/2	258066	10
1/2 x 3/4	258067	10
3/4 x 1/2	258068	10
3/4 x 3/4	258069	10
3/4 x 1	258070	10
1 x 3/4	258071	5
1 x 1	258072	5
1 x 1 1/4	258073	5
1 1/4 x 1	258074	1
1 1/4 x 1 1/4	258075	1
1 1/4 x 1 1/2	258076	1
1 1/2 x 1 1/2	258077	1
1 1/2 x 2	258078	1
2 x 2	258079	1

ID SERIES FITTINGS

FEMALE ADAPTORS – COMP X FI NPT



Size (in)	Product Code	Package Qty.
1/2 x 1/2	258080	10
1/2 x 3/4	258081	10
3/4 x 3/4	258082	10
3/4 x 1	258083	10
1 x 1	258084	5
1 x 1 1/4	258085	5
1 1/4 x 1 1/4	258086	1
1 1/4 x 1 1/2	258087	1
1 1/2 x 1 1/2	258088	1
1 1/2 x 2	258089	1
2 x 2	258090	1

ELBOW – COMP X COMP



Size (in)	Product Code	Package Qty.
1/2 x 1/2	258091	10
3/4 x 3/4	258092	10
1 x 1	258093	5
1 1/4 x 1 1/4	258094	1
1 1/2 x 1 1/2	258095	1
2 x 2	258096	1

ID SERIES FITTINGS

ELBOW – COMP X FI NPT



Size (in)	Product Code	Package Qty.
1/2 x 3/4	258097	10
3/4 x 3/4	258098	10
3/4 x 1	258099	10
1 x 1	258100	5
1 x 1 1/4	258101	5
1 1/4 x 1 1/4	258130	1

TEE – COMP X COMP X COMP



Size (in)	Product Code	Package Qty.
1/2 x 1/2 x 1/2	258102	10
3/4 x 3/4 x 3/4	258103	5
1 x 1 x 1	258104	5
1 1/4 x 1 1/4 x 1 1/4	258105	1
1 1/2 x 1 1/2 x 1 1/2	258106	1

ID SERIES FITTINGS

TEE – COMP X COMP X FI NPT



Size (in)	Product Code	Package Qty.
3/4 x 3/4 x 3/4	258107	10
1 x 1 x 1/2	258108	5
1 x 1 x 1	258109	5
1 1/4 x 1 1/4 x 1/2	258110	1
1 1/4 x 1 1/4 x 3/4	258111	1
1 1/4 x 1 1/4 x 1 1/2	258112	1
1 1/2 x 1 1/2 x 2	258113	1

END CAPS



Size (in)	Product Code	Package Qty.
1/2 x 1/2	258114	10
3/4 x 3/4	258115	10
1 x 1	258116	5
1 1/4 x 1 1/4	258117	1
1 1/2 x 1 1/2	258118	1

CONVERSION KITS

Philmac 3G Compression fittings are adaptable to different outside diameter configurations or pipe types by simply changing the insert assembly. Philmac 3G conversion kits offer you the versatility of connecting Copper tubing, Composite / Q-Line pipe and IPSOD pipe all with the same fitting body.

Conversion Instructions

1. Remove and discard existing nut, collet, insert, and seal.
2. Insert new seal. Ensure the seal is properly seated in the body of the fitting to eliminate the chance of leakage.
3. Insert new collet. Ensure the collet is properly seated against the seal.
4. Screw on the new nut until two threads are showing on the body.
5. Complete the installation according to the CTSOD installation instructions.



	BODY SIZE						
	2	3	4	5	6	6 (CTS)	7
Dedicated Fittings							
CTS	3/4"	1"	1 1/4"	1 1/2"	-	2"	-
ID Series	1/2"	3/4"	1"	1 1/4"	1 1/2"	-	2"
Conversion Kits							
IPSOD	-	3/4"	1"	1 1/4"	1 1/2"	-	2"
Composite / Q-Line	5/8"	3/4"	1"	-	-	-	-
Copper	1/2"	3/4"	1"	-	-	-	-

This chart allows you to easily determine which dedicated fitting and conversion kit are needed to convert the Philmac 3G compression fittings to suit your particular installation. Selecting the proper fitting and conversion kit can be done in three easy steps:

1. Select the size and type of pipe you want to convert to (Example: Convert to 5/8" Composite / Q-Line pipe)
2. Identify the Body Size for the size and type of pipe (For 5/8" Composite / Q-Line, the Body Size is 2)
3. Using the Body Size, find the corresponding dedicated fitting (Both 3/4" CTSOD or 1/2" ID Series have a Body Size of 2 and can be used to convert to 5/8" Composite / Q-Line)

NOTES

NOTE: For Composite / Q-Line it is necessary to re-round the pipe using the tool supplied to ensure the pipe sits easily in the internal seal. This must be done on the inside and outside of the pipe.



WARNING

WARNING: The nuts may look very similar; however, there are slight variances for each type of pipe. It is recommended that the old nut, collet, insert and seal are discarded prior to opening the conversion kit package to eliminate the chance of using an incorrect part.

Copper

Size	Product Code	Package Qty.
1/2	258119	1
3/4	258120	1
1	258121	1

COMPOSITE / Q-LINE

Size (in)	Product Code	Package Qty.
1/2	258122	1
3/4	258123	1
1	258124	1

IPSOD

Size (in)	Product Code	Package Qty.
3/4	258125	1
1	258126	1
1 1/4	258127	1
1 1/2	258128	1
2	258129	1

SYSTEM DESIGN CONSIDERATIONS

Projected Life of Compression Fittings

Although Philmac 3G Compression fittings have a minimum life of 50 years, they are intentionally developed to exceed the expectations of these specifications.

Effect of Temperature on Fitting Longevity

PROJECTED LIFE OF COMPRESSION FITTINGS

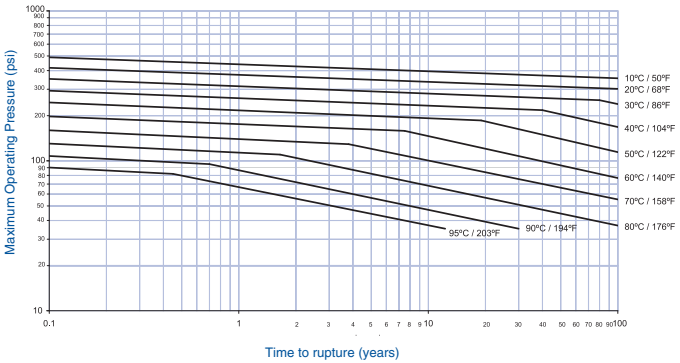

Fittings are rated at 230psi @ 73°F - see chart for life expectancy rating at higher temperatures.

Head losses

The following table offers a guide in estimating head losses in PE pipe systems based on the conveyance of water. Use the following formula to estimate this head loss:

$$L = F \times D$$

Where F = fitting constant

D = pipe inner diameter (m)

L = head loss based on equivalent pipe length (m)

Fitting	Fitting Constant (F)
90° Elbow	30
90° tee – Straight Through	12
90° Tee – Side Branch	60

Resistance to Impact

The thermoplastic materials used in the Philmac 3G Compression fittings have excellent impact properties.

Abrasion Resistance

Philmac 3G Compression fittings are suitable for the transportation of abrasive slurries and will withstand normal conditions found in urban, mining, industrial, rural water, and waste water systems.

Weathering

The materials used contain pigments to provide excellent protection to degradation due to ultra-violet radiation. Continuous use of the Philmac 3G Compression fittings in systems above ground is therefore permissible without additional protection.

Electrolytic Corrosion

Philmac 3G Compression fittings are non-magnetizing and do not cause electrolytic deterioration.

Thermal Insulation

Polypropylene has natural thermal insulation of 2000 times over copper and 200 times over steel.

Light Transmission

The all black Philmac 3G Compression fittings do not transmit light, thus protecting the water quality in potable water pipelines from growth of micro-organisms.

Effect on Water

Philmac 3G Compression fittings do not impart to water any odour, taste, colour, or any constituents in concentrations that could be injurious to health.

Fluids other than Water

Philmac 3G Compression fittings may convey a wide variety of fluids. The following table is provided as a guide only for the compatibility of various chemicals to Philmac 3G Compression fittings.

CHEMICAL	SATISFACTORY	NOT SATISFACTORY
Air	•	
Ammonium Hydroxide	•	
Alcohol	•	
Acetone		•
Auto Transmission Fluid	•	
Antifreeze	•	
Benzene		•
Butane	•	
Calcium Salts	•	
Caustic Soda (40% aqueous)	•	
Cresol		•
Citric Acid (10% aqueous)	•	
Copper Salts	•	
Ethylene Glycol	•	
Ethyl Glycol	•	
Diesel	•	
Formic Acid		•
Gasoline		•
Hydrochloric Acid		•
Kerosene		•
Mineral Oils	•	
Methane	•	
Methylene Chloride		•
Nitric Acid		•
Petroleum Oils	•	
Sewerage	•	
Sodium Cyanide	•	
Sulphuric Acid		•
Toluene		•
Turpentine		•
Transformer Oil	•	
Zinc Salt Solution	•	

NOTE: Fluid Temperature = 68°F

NOTES

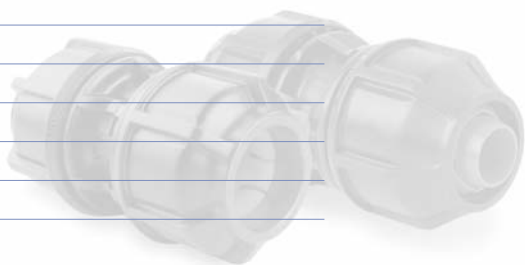

NOTES



SALES AND CUSTOMER SERVICE

IPEX Inc.

Toll free: (866) 473-9462

ipexna.com

About the IPEX Group of Companies

As leading suppliers of thermoplastic piping systems, the IPEX Group of Companies provides our customers with some of the world's largest and most comprehensive product lines. IPEX products are backed by more than 50 years of experience. With state-of-the-art manufacturing facilities and distribution centers across North America, we have earned a reputation for product innovation, quality, end-user focus and performance.

Markets served by IPEX group products are:

- Electrical systems
- Telecommunications and utility piping systems
- PVC, CPVC, PP, PVDF, PE, ABS, and PEX pipe and fittings
- Industrial process piping systems
- Municipal pressure and gravity piping systems
- Plumbing and mechanical piping systems
- Electrofusion systems for gas and water
- Industrial, plumbing and electrical cements
- Irrigation systems

Products are manufactured for IPEX Inc.

P O T A B L E W A T E R S Y S T E M S

This literature is published in good faith and is believed to be reliable. However, it does not represent and/or warrant in any manner the information and suggestions contained in this brochure. Data presented is the result of laboratory tests and field experience.

A policy of ongoing product improvement is maintained. This may result in modifications of features and/or specifications without notice.