



Installation Guide

PVC Pressure Piping Systems

M U N I C I P A L S Y S T E M S

PVCO CIOD PRESSURE PIPE – 4" (100mm) to 18" (450mm)

PVC CIOD PRESSURE PIPE & FITTINGS – 4" (100mm) to 60" (1500mm)

PVC IPS PRESSURE PIPE & FITTINGS – 1-1/2" (40mm) to 24" (600mm)

PVC PIPING SYSTEMS FOR HDD & OTHER TRENCHLESS APPLICATIONS
4" (100mm) to 12" (300mm)



IPEX
Committed to Excellence

We build tough products for tough environments®

TABLE OF CONTENTS

Introduction	3
Pressure Pipe & Fittings Meet These Standards	4
Receiving & Handling Pipe Shipments	5
Before Accepting the Shipment	5
Handling the Pipe and Fittings	5
Storage at the Job Site	6
Cold Weather	7
Stockpiling	7
Outdoor Storage	7
Trench Preparation	8
Safety	8
Excavating and Preparing the Trench	8
Depth of Trench	9
Flotation	9
The Bottom of the Trench	9
Lowering Pipe & Fittings into the Trench	10
Assembling IPEX Joints	11
Preparation	11
Lubrication	12
Assembly	12
For Sizes over 36 inches (900mm)	13
Curvature of the Pipeline	14
Using PVC Fittings	14
Deflecting the Joint	15
Bending the Pipe Barrel	16
Assembling to Iron Appurtenances	17
Assembling to Cast Iron Fittings	17
Assembling to Butterfly Valves	17
Cutting and Chamfering the Pipe	18
Cutting	18
Chamfering	18
Dimensions	19
Blue Brute®/IPEX Centurion®	20
Cycle Tough® Series	20
Bionax PVC0	22
Outside Diameter Considerations	22
Blue Brute and Centurion PVC Pipe: CIOD	22
Cycle Tough PVC Pipe: IPS OD	23
Bionax PVC0 Pipe: CIOD	23
CIOD Injection-Molded PVC Fittings	24
Dimensional Data	25



IPS Injection-Molded PVC Fittings	31
Engineered Joint	32
Dimensional Data	33
Fabricated PVC Pressure Fittings	38
Bionax® SR™ Seismic Applications	39
TerraBrute® CR Trenchless Applications	41
Dimensions	41
Minimum Bending Radius	42
Joint Deflection Radius	42
Maximum Allowable Pull Forces	42
Joint Assembly Instructions	43
General Recommendations	43
Resisting Thrust at Fittings & Valves	47
Bearing Strength of Undisturbed Soils	48
Resisting Thrust in Very Poor Soils	48
Resisting Vertical Thrust	50
Holding Pipe to Steep Slopes	51
Mechanical Thrust Restraints	51
Flanged Joints	52
Tapping and Service Connections	52
Direct Tapping	52
Service Saddles	52
Tapping Sleeve and Valve	53
Tapped Couplings	54
The Two Backfills and Haunching	55
Initial Backfill	55
Final Backfill	55
Compacting the Backfill	56
Shallow Bury Considerations	57
Percent Deflections Charts	58
Testing	66
Checklist	66
Filling the Line	66
How Much Water is Needed	67
Pressure and Leakage Tests	67
Repairs	71
Installing the Pipe Through Casings	72
Precautions	72
Casing Size	72
Skids	73
Mechanical Casing Spacers	73
Casing Spacer Installation	74
Sealing the Casing	74
Lubricant Usage	76
Notes	77

RECOMMENDED PRACTICES FOR THE INSTALLATION OF IPEX PVC PRESSURE PIPE & FITTINGS

Introduction

This booklet will answer the needs of pipe installers looking for general recommendations on how to lay IPEX gasketed PVC pressure pipes and fittings. Out-of-the-ordinary conditions not covered here should be referred to the Engineer or field inspectors to provide on-site solutions. In such cases IPEX's advice is always available. Our objective is to encourage the use of methods that lead to a professional installation that will ensure the maximum service life for the pipe.

The Engineer who designs the pipeline will determine how it is to be installed. It is not our intention that the Guide should assume that responsibility unless the Engineer so directs.

This booklet sets out the preferred methods of installation based on IPEX's experience and on a number of published reports from other industry sources. Users will find additional helpful advice in "Recommended Practice for the Installation of PVC Pressure Pipe", AWWA C605, published by the American Water Works Association.

Readers are invited to order a copy of the "Uni-Bell Handbook of PVC Pipe - Design and Construction". This comprehensive reference manual covers all aspects of design and installation for PVC pipe & fittings. Call Uni-Bell at (972) 243-3902 to order.

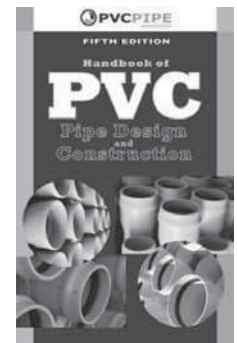

Pressure Pipe and Fittings Meet These Standards

Canadian Standards Association

B137.2 “Polyvinylchloride (PVC) injection-molded gasketed fittings for pressure applications”

B137.3 “Rigid polyvinylchloride (PVC) pipe and fittings for pressure applications”

B137.3.1 “Molecularly oriented polyvinylchloride (PVCO) pipe for pressure applications”

ASTM

D2241 “Poly (Vinyl Chloride) (PVC) Pressure-Rated Pipe (SDR Series)”

F1483 “Oriented Polyvinyl Chloride, PVCO, Pressure Pipe”

American Water Works Association

AWWA C900 “Polyvinyl Chloride (PVC) Pressure Pipe and Fabricated Fittings, 4" through 60", for Water Transmission and Distribution”

AWWA C907 “Polyvinyl Chloride (PVC) Pressure Fittings for Water – 4" through 12" (100 mm through 300 mm)”

AWWA C909 “Molecularly Oriented Polyvinyl Chloride (PVCO) Pressure Pipe, 4" through 24" (100 mm through 600 mm) for Potable Water, Wastewater, and Reclaimed Water Service”

BNQ

NQ 3624-250 “Unplasticized Poly(Vinyl Chloride) [PVC-U] Pipe and Fittings - Rigid Pipe for Pressurized Water Supply and Distribution - Characteristics and Test Methods”

RECEIVING AND HANDLING PIPE SHIPMENTS

Before Accepting the Shipment

IPEX pipe and fittings are manufactured to a number of standards, none of which are more demanding than IPEX's own Standard Product Specifications. Quality Control inspection of the products before they leave our plants ensures that only the highest quality products are shipped. Damage to the pipe, or shortages, are possible and must be checked before the shipment is signed for by the contractor.

1. Walk around the vehicle to make sure there has been no shifting of the load during transport. If there is some indication of shifting in transit, the contractor should inspect each piece as it is unloaded.
2. Check the quantity shipped against the tally sheet. The contractor must note any shortages on the trucker's bill of lading.
3. Carefully note any sign of damage to the pipe in the form of cracks, chips or other damage. Damage depth is considered significant if it is more than 10% of the thickness of the pipe wall.
4. DO NOT THROW AWAY ANY DAMAGED MATERIAL. Mark it carefully for further inspection by the carrier or his representative.
5. Re-order any material that is needed to make up for missing or damaged items.
6. Notify the carrier immediately and enter a claim for damaged or missing parts in accordance with their instructions.

Handling the Pipe and Fittings

Pipe arrives at the job site in standard pallet size units. The preferred method of unloading is to keep the pipe in the units as shipped and use mechanical equipment such as fork lifts, cherry pickers or front end loaders with forks. Do not slide the equipment forks against the underside of pipe in a pallet. This may damage the pipe by abrasion.

When the pipe is unloaded in full units they should be stored on level ground and they should not be stacked more than 2 units high. The units should be supported by dunnage in the



same way they were protected while on the transport. The weight of the unit should be borne by the dunnage rather than the pipe.

Units of pipe should not be lifted with single cables or chains. The wooden frames around the units should not be used as lifting points. Use straps and spreaders about 12 feet (3.7m) apart looped under the load.

Should mechanical equipment not be available, caution should be exercised when the pipe is unloaded by hand. Each unit or crate of pipe will be approximately 4 feet (1.2m) wide and will vary in height depending on the size of pipe in the unit. Where several tiers of pipe are in the unit they will be held in place with steel straps. By undoing the outer strap the top tier of pipe may be unloaded by individual lengths. The length behind the one being unloaded should be held in place with wooden chocks. Lighter pipes may be carefully handed down from the top of the load, but heavier pipes will require the use of ropes and skids. As each tier is unloaded, the interlacing straps are broken to provide access to the lower tier.

Storage at the Job Site

The preferred method of storage at the job site is in units or crates as shipped.

When the pipe is strung along the trench, place it as close as possible to the line of the trench, to the side opposite the area reserved for the storage of spoil. Locate the pipes where they can be lowered into the trench with the least amount of additional handling.

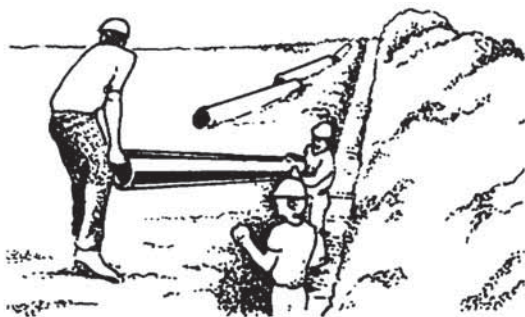

In Very Cold Weather

Although PVC pipe has very good impact resistance, it becomes stiffer and offers reduced impact resistance at very low temperatures. Recommended handling as described above is all that is required under these conditions. Do not allow the pipe to fall off the truck or into the trench. Individual lengths of pipe should not impact on each other as they are unloaded or stockpiled.

Stockpiling

Where it is necessary to remove pipe from their crates for storage, individual lengths should be placed on level ground and secured to prevent them from rolling.

Prolonged Outdoor Storage

Prolonged exposure of PVC pipe to the direct rays of the sun has no practical effects on the performance of the pipe. However some discoloration may take place in the form of a milky film on the exposed surfaces. This change in color merely indicates that there has been a chemical transformation at the surface of the pipe. A small reduction in impact strength could occur at the discolored surfaces. Other strength properties such as pressure capacity and structural strength are completely unaffected by this discoloration.

Discoloration of the pipe can be avoided by shading it from the direct rays of the sun. This can be accomplished by covering the stockpile or the crated pipe with an opaque material such as canvas. If the pipe is covered, always allow for the circulation of air through the pipe to avoid heat buildup in hot summer weather. Make sure that the pipe is not stored close to sources of heat such as boilers, steam lines, engine exhaust outlets, etc.



TRENCH PREPARATION

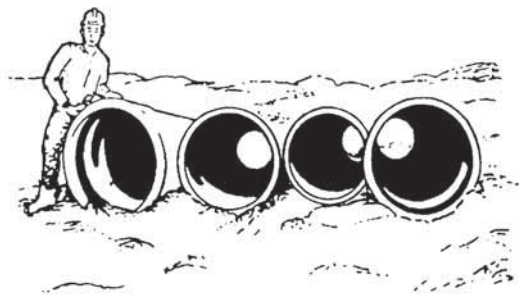

Safety

Trenches can be dangerous places. The contractor is responsible for ensuring that all applicable regulations have been observed and that the protection of the workers and the general public is provided.

Excavating and Preparing the Trench

The drawings and bid documents will specify the correct line and grade to be established by the trenching operation. Aside from these engineering considerations, good bedding practices make sense for all types of pipes, including PVC.

The width of the top of the trench will be determined by local conditions. But in the pipe zone the trench width should be kept to a practical minimum.

The general rule is that the maximum width at the top of the pipe should not be more than the outside diameter of the pipe plus 24" (600mm). If trench width cannot be controlled and will exceed the maximum then compacted backfill must be provided for a distance of 2-1/2 pipe diameters to either side of the pipe or to the trench wall, for pipe sizes up to 10" (250mm). For larger sizes the compacted haunching material should be placed one pipe diameter or 24" (600mm), (whichever is greater) to either side of the pipe. This lateral spacing will facilitate easy placement and shovel-slicing of bedding material in the haunch zone of the trench. The minimum distance required is 8" (200mm) on either side of the pipe.

Keep the three basic operations close together: digging, pipe laying and backfilling. The shortest practical stretch of open trench reduces the possibility of problems associated with water, frozen ground, impact damage, flotation, and traffic.

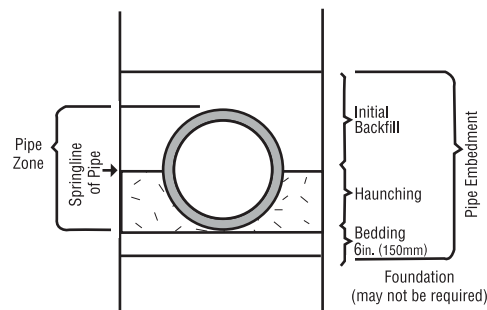

Depth of Trench

For water distribution and transmission lines, pipe should be buried so that the top of the pipe is at least 6" (150mm) below the deepest recorded penetration of frost. Where surface loads will be encountered and where frost is not a problem, the minimum height of cover over the crown of the pipe is 12" (300mm). Before vehicles pass over the line of the pipe under shallow cover, make sure embedment material has been completed and compacted to at least 95% standard proctor density and has a minimum modulus of soil reaction (E') of 1000psi.

Flotation

Where it is not possible to remove standing water from the trench and the pipe will be in a flooded condition, it should be held at grade with a soil cover of at least twice the pipe diameter.

The Bottom of the Trench

The objective of bedding is to provide a continuous support for the pipe at the required line and grade. Frozen material should not be used to support or bed the pipe. At least 4" (100mm) of bedding material should be placed under the pipe if rocky conditions exist. The bedding may or may not be compacted, but in any event the projecting bells of the pipe should be properly relieved in the trench bottom so that the entire pipe is evenly supported by the bedding. Where the trench bottom is unstable (organic material, or "quick" sand or similar material) the trench bottom should be over-excavated and brought back to grade with approved material.

Often today, local labor codes require the use of a trench box or sheeting to support the walls of an open trench. Removal of



these supports after pipe installation may leave gaps in the pipe zone of the trench. These voids should be filled in with additional embedment material after sheeting removal. In some cases, it may be desirable to leave the sheeting in place as part of the pipe embedment, or to use a 'notched' trench box as shown below.

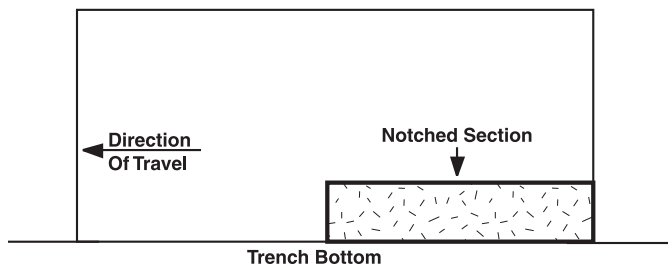

LOWERING THE PIPE AND FITTINGS INTO THE TRENCH

Place the pipe and fittings into the trench using ropes and skids, slings on the backhoe bucket, or by hand. Do not throw the pipe or fittings into the trench or allow any part of the pipe to take an unrestrained fall onto the trench bottom. At this point the pipe and other accessories are in a good position for final inspection. Ensure there are no damaged materials before assembly begins.



ASSEMBLING IPEX JOINTS

Preparation

All IPEX PVC pipe and fittings are prepared for assembly as follows:

Keep both the spigot and the bell clean. It is good practice to lay PVC pressure pipe with bells forward so that the assembly operation will consist of pushing the spigot into the bell. This will minimize the possibility of contaminating the surfaces with foreign material. All assemblies should be concentric.

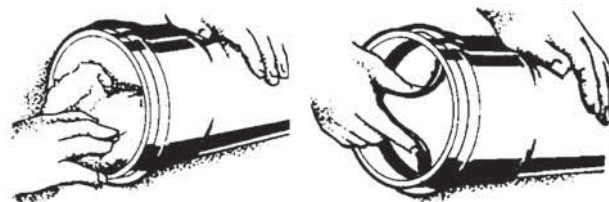

Use only IPEX PVC pipe lubricant. The use of substitute lubricants may affect water quality or damage the gaskets. For most pipes, gaskets are factory-installed.

If the gasket is not pre-installed: before inserting the gasket, make sure that it is clean and that the bell groove is free of any debris or dirt. Then carefully position the gasket in the groove. Gaskets are not interchangeable – **USE ONLY THE GASKETS SUPPLIED BY IPEX.**

If the gasket is already installed: it is usually not necessary to remove the gasket for cleaning.

Clean the inside of the bell (including the face of the gasket), and the outside of the spigot with a rag, brush, or paper towel to remove any dirt or foreign material before assembling.

The pipe is shipped with a chamfer on the end of the spigot. If there is no chamfer, follow the example of a factory-made spigot and machine a suitable chamfer.



Form the chamfer using a beveling tool, hand rasp or disk cutter.





Lubrication

Apply a thin coating of lubricant (equivalent to a brushed coating) using a glove, a rag, or a paint brush. The area to be covered is as follows:

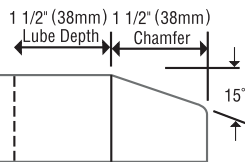
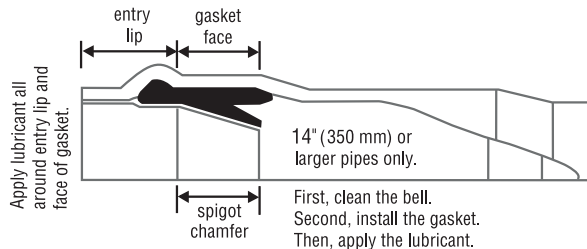

Apply lubricant all around the pipe nose on chamfer & 1 1/2" (38mm) back.

*For proper lubricant usage refer to page 74.

NOTE: Gasket drawings are for information only. Actual gaskets may vary.

Assembly

Keeping the spigot out of the dirt, position it so that the chamfer is resting against the gasket in the bell. Push the spigot into the bell until the assembly line on the spigot is even with the edge of the bell. If there are two assembly lines the edge of the bell should line up between them.

The assembly effort can be delivered by hand in small diameters with the aid of a twist as the spigot enters the bell, or by using a bar and block. Other assembly methods include lever pullers, hydraulic jacks, and for large diameter pipes the IPEX Pipe Puller.

Where mechanical means, such as a backhoe, are used, the assembly effort should not be applied directly to the edge of

the pipe. A two by four or a plank should be placed between the backhoe bucket and the edge of the pipe. The use of a backhoe bucket has the disadvantage that the backhoe operator is unable to see clearly when the assembly is complete. Thus, a helper should be located near the joint to signal when the assembly is complete.

NOTE: *Factory-made assembly lines on the pipe do not indicate correct assembly to fittings.*

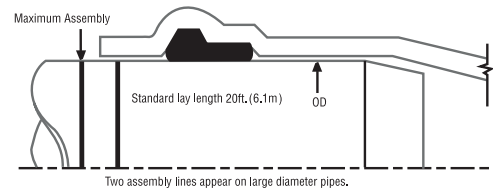

OVER-ASSEMBLY OF THE JOINT COULD DAMAGE THE BELL OF THIS OR ADJACENT PIPE LENGTHS. MAKE SURE THAT PREVIOUSLY ASSEMBLED JOINTS REMAIN UNDISTURBED.

If resistance is felt to the assembly, it may mean that the sealing gasket has somehow become dislodged. If so, the joint should be disassembled, cleaned, and reconstructed in accordance with the methods given above.

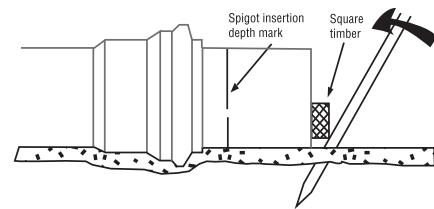

NOTE: *If there are no assembly lines visible on the pipe, the minimum and maximum insertion depths shown on pgs. 19, 20, 21 & 22 should be marked on the pipe by hand.*

For Sizes Over 36 inches (900mm)

Consideration should be given to the use of come-along devices for assembly of the gasketed joint in these sizes. A minimum of 1/2" (13mm) thickness of chain should be used. IPEX also has available a motorized come-along apparatus known as a Pipe Puller. Contact IPEX for details.



CURVATURE OF THE PIPELINE

There are three common methods used to achieve changes in direction with IPEX Pressure Pipe. They are 1) using PVC fittings, 2) deflecting the joint, 3) bending the pipe barrel.

Using PVC Fittings

Pipeline curvatures can be achieved by using IPEX PVC fittings. Standard elbows for molded fittings include 22 1/2, 45 and 90 degrees. Blue Brute™ or Cycle Tough™ fittings offer an additional 1° of offset capacity at each bell. To achieve greater changes in direction, IPEX offers 5° CIOD bends in DR18 up to 24 inches (600 mm). The cut lengths and radii are as follows:

Size		Cut Length		Radius	
in	mm	in	mm	ft	m
6	150	36	910	22	6.7
8	200	36	910	21	6.3
10	250	42	1070	26	7.9
12	300	48	1220	30	9.2
14	350	60	1520	40	12.2
16	400	72	1830	48	14.6
18	450	74	1870	49	14.8
20	500	82	2080	54	16.5
24	600	98	2480	67	20.3

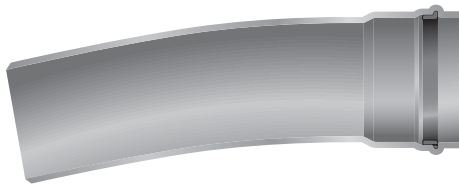

Deflecting the Joint

The procedure for offsetting the IPEX gasketed joint is shown below. *Do not combine this method with bending the pipe barrel. (IPEX does not recommend deflecting Bionax SR pipe joints.)*

1. Make a concentric assembly, but push the spigot into the bell only to a point about 1/2 inch (13mm) short of the reference line (the first reference line if there are two). This incomplete assembly permits more movement of the end of the pipe at the bottom of the bell.
2. Without delay, shift the loose bell end of the assembled length by not more than the following recommended maximum offsets. Use only manual effort.

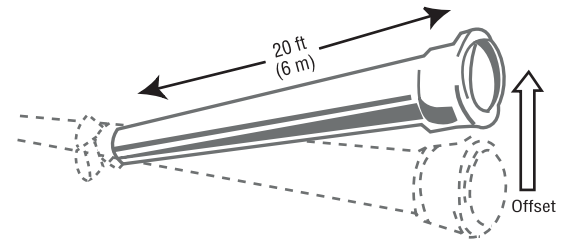

MAXIMUM RECOMMENDED OFFSETS, TO ACHIEVE MINIMUM CURVE RADIUS BY DEFLECTING A STRAIGHT LENGTH OF PIPE AT THE JOINT (FOR ALL PRODUCTS)

Pipe Size		Max Offset		Angle at One Bell	Resulting Radius of Curvature Using 20ft (6m) Lengths	
in	mm	in	mm		ft	m
4	100	12-1/2	320	3°	382 ft	116 m
6	150	12-1/2	320	3°	382 ft	116 m
8	200	12-1/2	320	3°	382 ft	116 m
10	250	12-1/2	320	3°	382 ft	116 m
12	300	10-1/2	270	2.5°	458 ft	140 m
14 – 24	350 – 600	6-1/4	160	1.0°	1146 ft	349 m
30 – 60	750 – 1500	4	100	1.0°	1146 ft	349 m
At Molded PVC Fittings (all sizes)		4	100	1.0°**	1146 ft	349 m

** Bell-by-Bell fittings such as tees and couplings offer a total of 2° deflection per fitting.

(IPEX does not recommend deflecting Bionax SR pipe joints.)



Bending the Pipe Barrel

Smaller diameters of IPEX PVC pressure pipes can be laid to the line of curved trench by bending the pipe barrel into a curved shape. The procedure is as follows:

1. Make a concentric assembly in the usual way. Keep the spigot in straight alignment with the bell.
2. Place compacted backfill around the assembled joint to restrict its movement while the curvature is being made.
3. Place compacted backfill at the inside of the curve, at the mid-point of the pipe length, to form a fulcrum.
4. **Using only manual effort**, move the leading bell of the pipe length to be curved by no more than the offset distance shown in the following table.
5. **Do not cut service taps into bent PVC pipe. Tapping bent PVC pipe is permitted.**

NOTE: Bent pipes should be clearly marked along their length to avoid the possibility that they will be tapped in the future.

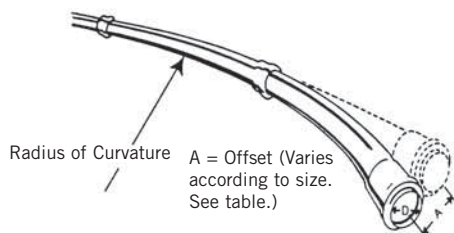

MAXIMUM RECOMMENDED OFFSET, A, TO ACHIEVE MINIMUM RADII OF CURVATURE BY BENDING THE BARREL OF 20 ft (6 m) LENGTHS

CIOD Pipe – Blue Brute®, Bionax® & Bionax® SR™ C909 Pipe

Pipe Size D	Max Offset		Resulting Angle of Deflection	Resulting Radius of Curvature	
	in	mm		ft	m
4	100	24	600	5.7°	100 30
6	150	17	430	4.0°	144 44
8	200	13	300	3.0°	188 58
10	250	10	254	2.5°	232 71
12	300	8.7	221	2.1°	275 84

NOTE: Minimum radius is approximately 250 times nominal OD

IPS OD Pipe – Cycle Tough® F1483 Pipe

Pipe Size D	Max Offset A		Resulting Angle of Deflection	Resulting Radius of Curvature	
	in	mm		ft	m
4	100	32	813	7.6°	75 23
6	150	22	560	5.2°	111 34
8	200	17	430	4.0°	144 44
10	250	13	330	3.2°	179 55
12	300	11	280	2.7°	213 65

NOTE: Minimum radius is approximately 200 times nominal OD

* SDR and DR both refer to the outside diameter of the pipe divided by pipe thickness: $\frac{O.D.}{t}$

ASSEMBLING TO IRON APPURTENANCES

Assembling to Cast Iron Fittings

The bells of both mechanical joint and push-fit iron fittings are much shallower than the bells of IPEX pipe. For this reason, the assembly line on the pipe spigot is of no value as an indicator of proper assembly to cast iron fittings. In order to fully engage the gasket of the iron push-fit bell, the chamfer of the PVC pipe spigot should be essentially removed. Leave only an eighth of an inch of chamfer when assembling to push-fit joints. When completing the mechanical joint, remove all the pipe chamfer and reduce the torque requirements quoted for iron assemblies. The gasket used in mechanical joint fittings should be duck tipped. Do not attempt to deflect joints made to iron fittings.

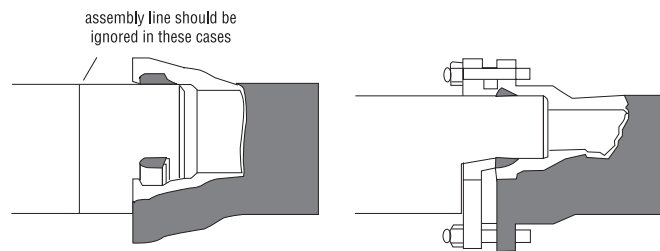

Leave a slight chamfer on CIOD PVC pipe assembled to push-fit cast iron fittings. Bottom the pipe in the iron bells.

Square-cut the edge of PVC pipes assembled to M-J cast iron fittings.

Pipe Size	Bolt Torque
4"-24" (100 - 600mm)	70 - 80 ft lbs (95-108N-m)
30"-36" (750 - 900mm)	90 - 100 ft lbs (122-136N-m)
42"-60" (1050 - 1500mm)	125 - 150 ft lbs (170-200N-m)

Assembling to Butterfly Valves

When heavy-wall PVC pipes, such as DR14, are assembled to butterfly valves there is a possibility that the inside edge of the pipe may interfere with the swing of the disc. In this case, a 1/2" (13mm) 45° chamfer on the inside edge of the pipe spigot will provide the needed clearance.



CUTTING AND CHAMFERING THE PIPE

Cutting

A square cut is important. With smaller diameter pipes a mitre-box can be used with a hand saw to complete the cut. With large diameter pipes, which are difficult to lift, select a flat piece of ground and roll the pipe across the ground while scribing a cutting line on the pipe wall with a felt pen. This line should be placed carefully to ensure a square cut. The rolling action may also be used to feed a power tool along the cutting line. Use an abrasive disc or steel saw blade while not force-feeding the tool in a manner that causes burns.

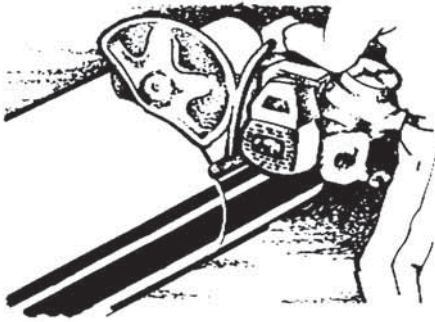

Chamfering

The chamfer on pipe supplied from the factory is about 15°. Using the factory pipe as a guide, the cut length should be chamfered to approximately the same angle and distance back. There are a number of ways of chamfering pipe: A power sander or abrasive disc, a router, and a rasp or file, may be used. When assembling to iron fittings, only a short bevel of about 1/8" (3mm) or so should be made to the cut edge.

To ensure correct assembly of cut pipe to IPEX joints, mark an assembly line on the spigot end with a felt pen. Use other pipe lengths as a guide, or use the dimensions in the tables on the next pages.

DIMENSIONS

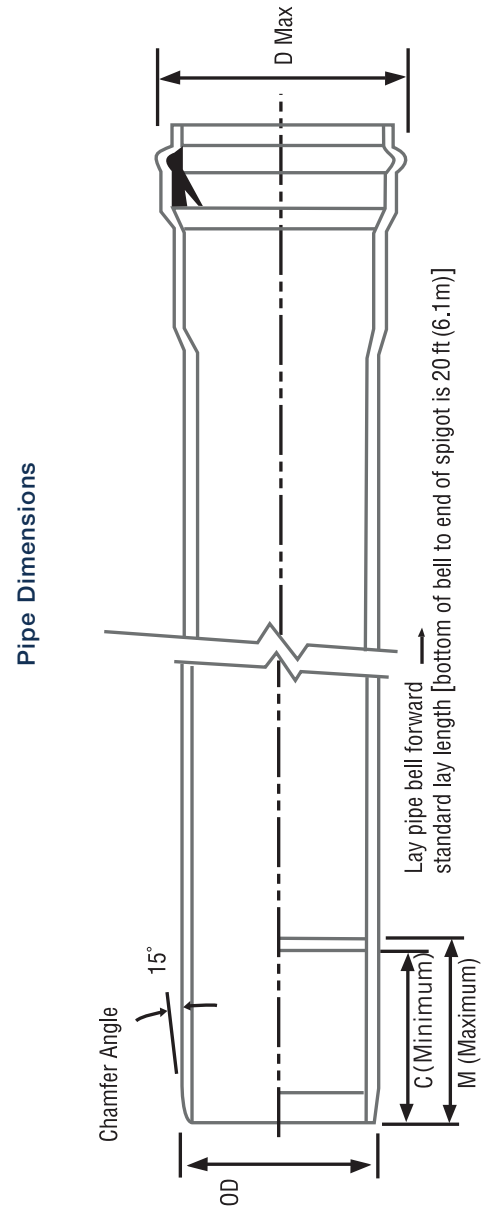

Dimensions of Blue Brute and IPEX Centurion Pressure Pipes with CIOD's

Nominal Size		Average OD		Minimum Insertion C		Maximum Insertion M		D max													
								DR 51		DR 41		DR 32.5		DR 25		DR 18		DR 14			
in	mm	in	mm	in	mm	in	mm	in	mm			in	mm	in	mm	in	mm	in	mm	in	mm
4	100	4.8	122	5.8	148	-	-	-	-			-	-	-	-	6.0	152.35	6.1	156.18	6.3	160.08
6	150	6.9	175	6.4	163	-	-	-	-			-	-	-	-	8.3	210.04	8.5	215.55	8.7	221.16
8	200	9.1	230	7.1	181	-	-	-	-			-	-	-	-	10.8	273.07	11.0	280.29	11.3	287.66
10	250	11.1	282	7.6	192	-	-	-	-			-	-	-	-	13.3	338.61	13.7	347.47	14.0	356.50
12	300	13.2	335	8.1	207	-	-	-	-			-	-	-	-	15.6	395.63	16.0	406.15	16.4	416.90
14	350	15.3	388.6	8.0	203	9.0	229	-	-			17.7	449.84	18.0	456.34	18.2	462.08	18.7	474.28	19.2	486.73
16	400	17.4	442.0	10.0	254	11.0	279	-	-			20.0	508.80	20.3	516.20	20.6	522.72	21.1	536.59	21.7	550.75
18	450	19.5	495.3	10.5	267	11.5	292	22.0	558.5			22.3	567.56	22.7	575.85	23.0	583.16	23.6	598.71	-	-
20	500	21.6	548.6	11.5	292	12.5	318	22.2	562.78			24.9	632.41	25.3	641.60	25.6	649.70	26.3	666.92	-	-
24	600	25.8	655.3	13.0	330	14.0	356	29.3	745.41			29.6	751.74	29.9	760.17	30.4	772.38	31.2	792.96	-	-
30	750	32.0	812.8	14.5	368	15.5	394	35.8	908.98			36.1	916.83	36.5	927.29	37.1	942.43	-	-	-	-
36	900	38.3	972.8	15.5	393	16.5	419	42.5	1079.90			42.9	1089.29	43.4	1101.82	44.1	1119.94	-	-	-	-
42	1050	44.5	1130.3	16.0	406	17.0	432	48.8	1240.00			49.4	1255.00	50.0	1270.00	50.9	1293.00	-	-	-	-
48	1200	50.8	1290.3	17.0	432	18.0	457	55.5	1409.00			56.1	1424.00	56.7	1441.00	57.8	1467.00	-	-	-	-
54	1350	57.6	1462.0																		
60	1500	61.6	1564.9																		

Dimensions of Cycle Tough Pressure Pipes with IPS OD's

Nominal Size		Average OD		Minimum Insertion C		Maximum Insertion M		D max									
								DR 41		DR 32.5		DR 26		DR 21			
in	mm	in	mm	in	mm	in	mm			in	mm	in	mm	in	mm	in	mm
1-1/2	40	1.900	48.3	3.3	83	-	-			-	-	-	-	2.75	70.00	2.75	70.00
2	50	2.375	60.4	3.7	93	-	-			-	-	-	-	3.32	84.00	3.37	85.00
2-1/2	65	2.875	73.0	4.2	106	-	-			-	-	-	-	3.82	97.00	3.87	98.00
3	75	3.500	88.9	4.8	121	-	-			-	-	-	-	4.54	115.00	4.60	117.00
4	100	4.500	114.3	4.8	123	-	-			5.5	139.36	5.5	140.83	5.60	142.61	5.70	144.72
6	150	6.625	168.3	4.8	123	-	-			7.8	198.16	7.9	200.33	8.00	202.94	8.10	206.05
8	200	8.625	219.1	5.4	138	-	-			10.1	255.39	10.2	258.21	10.30	261.61	10.50	265.66
10	250	10.750	273.1	6.3	161	-	-			12.6	319.25	12.7	322.77	12.90	372.01	13.10	332.06
12	300	12.750	323.9	6.5	165	-	-			14.7	372.81	14.8	376.98	15.00	382.01	15.30	388.00
14	350	14.000	355.6	7.0	178	8.0	203			16.2	411.33	16.4	415.91	16.60	421.43	16.90	428.00
16	400	16.000	406.4	8.9	227	9.9	252			18.5	469.84	18.7	475.07	19.00	481.38	19.20	488.89
18	450	18.000	457.2	9.9	252	10.9	276			20.7	526.06	20.9	531.95	21.20	539.05	21.60	547.50
20	500	20.000	508.0	10.7	272	11.7	297			23.1	585.84	23.3	592.38	23.60	600.26	24.00	609.65
24	600	24.000	609.6	11.7	296	12.7	322			27.5	697.78	27.8	705.63	28.20	715.10	28.60	726.37



Dimensions of Bionax & Bionax SR PVC Pressure Pipes with CIODs

PC/PR 1135 kPa (165 psi)

Nominal Size		Average OD		Insertion		D max		Average ID	
in	mm	in	mm	in	mm	in	mm	in	mm
14	350	15.30	389	9.06	230	17.64	448	14.57	370
16	400	17.40	442	10.51	267	20.04	509	16.57	421
18	450	19.50	495	11.32	288	22.40	569	18.54	471
20	500	21.60	549	12.15	309	24.57	624	20.59	523
24	600	25.80	655	13.42	341	29.33	745	24.53	623
30	750	32.00	813	15.63	397	35.98	914	30.43	773

PC/PR 1620 kPa (235 psi)

Nominal Size		Average OD		Insertion		D max		Average ID	
in	mm	in	mm	in	mm	in	mm	in	mm
4	100	4.80	122	5.63	143	6.10	155	4.48	114
6	150	6.90	175	6.22	158	8.49	216	6.44	164
8	200	9.05	230	6.93	176	10.83	275	8.45	215
10	250	11.10	282	7.87	200	13.33	339	10.37	263
12	300	13.20	335	8.39	213	15.60	396	12.33	313
14	350	15.30	389	9.06	230	17.99	457	14.33	364
16	400	17.40	442	10.51	267	20.39	518	16.30	414
18	450	19.50	495	11.32	288	22.76	578	18.23	463
20	500	21.60	549	12.15	309	24.96	634	20.16	512
24	600	25.80	655	13.42	341	29.76	756	24.02	610
30	750	32.00	813	15.63	397	36.57	929	29.84	758

PC/PR 2100 kPa (305 psi)

Nominal Size		Average OD		Insertion		D max		Average ID	
in	mm	in	mm	in	mm	in	mm	in	mm
14	350	15.30	389	9.06	230	18.23	463	13.96	354
16	400	17.40	442	10.51	267	20.59	523	15.88	403
18	450	19.50	495	11.32	288	22.91	582	17.80	452
20	500	21.60	549	12.15	309	25.35	644	19.72	501
24	600	25.80	655	13.42	341	30.16	766	23.54	598
30	750	32.00	813	15.63	397	37.20	945	29.20	742

Bionax SR 1620 kPa (235 psi)

Nominal Size		Average OD		Insertion		D max		Average ID	
in	mm	in	mm	in	mm	in	mm	in	mm
6	150	6.90	175	7.68	195	8.49	216	6.44	164
8	200	9.05	230	9.25	235	10.83	275	8.45	215
10	250	11.10	282	9.65	245	13.33	339	10.37	263
12	300	13.20	335	12.00	305	15.60	396	12.33	313

OUTSIDE DIAMETER CONSIDERATIONS

IPEX pressure pipes are available in two different outside diameter regimes in most nominal sizes. These are Cast Iron (CIOD) and Iron Pipe Size (IPS) Outside Diameters. The dimensions for each configuration are shown in the tables on pages 20, 21, and 22.

Blue Brute & Centurion PVC Pipe: Cast Iron Outside Diameter (CIOD)

These are the pipe and fittings normally associated with the American Water Works Association Standards C900 and C907. IPEX offers sizes of 4, 6, 8, 10 and 12" (100, 150, 200, 250 and 300mm) with CIOD's in Pressure Class (PC) 165 (DR25), PC 235 (DR18) and PC 305 (DR14). Also available are pipe sizes 14" (350mm) through 60" (1500mm) with CIODs in PC 80 (DR51), PC 100 (DR41), PC 125 (DR32.5, to 54" only), PC 165 (DR25, to 48" only) and PC 235 (DR18, to 42" only) All CIOD PVC Pressure Pipes by IPEX are certified to CSA B137.3 and meet AWWA standards.

Pipes having CIOD are adaptable directly to molded or fabricated PVC fittings, cast iron fittings, valves and other appurtenances. For the iron fittings and valves, preparation of the PVC pipe end must reflect the reduced insertion depth of these fittings.

Cycle Tough PVC Pipe: Iron Pipe Size (IPS) Outside Diameter

IPEX Series gasketed pipes with IPS O.D. (equivalent to steel pipe outside diameters) are available in sizes ranging from 1-1/2" (40mm) through 24" (600mm). All IPEX Series pipe is certified to CSA B137.3 and conforms fully to ASTM D 2241. These pressure rated pipes fit directly into IPS Cycle Tough injection molded fittings. They also fit into Blue Brute or iron fittings by using transition gaskets or adapters. These adapters are available with either spigot or bell ends and are approximately 24" (600mm) long.

Bionax PVC Pipe: Cast Iron Outside Diameter (CIOD)

This is pipe associated with the American Water Works Association Standard C909. IPEX offers CIOD sizes 4, 6, 8, 10, 12", 14", 16", 18", 20", 24" and 30" (100, 150, 200, 250, 300, 350, 400, 450, 500, 600, 750 mm) in Pressure Class 235 and Pressure Class 305. This pipe is also available in Pressure Class 165 in CIOD sizes 14", 16", 18", 20", 24" and



30" (350, 400, 450, 500, 600, 750 mm). Bionax and Bionax SR pressure pipes are third-party certified to the AWWA C909 standard.

This pipe also is associated with Canadian Standards Association B137.3.1. IPEX offers CIOD sizes 4, 6, 8, 10, 12", 14", 16" and 18", 20", 24" and 30" (100, 150, 200, 250, 300, 350, 400 and 450, 500, 600 and 750 mm) in Pressure Rated 1135 kPa, 1620 kPa and 2100 kPa. Bionax and Bionax SR CIOD pressure pipes are third-party certified to the CSA B137.3.1 standard.

Pipes having CIOD are adaptable directly to molded or fabricated PVC fittings, cast iron fittings, valves, and other appurtenances. For the iron fittings and valves, preparation of the Bionax pipe end must reflect the reduced insertion depth of these fittings.

CIOD INJECTION-MOLDED PVC FITTINGS

Introduction

IPEX Blue Brute PVC injection molded fittings are available for CIOD pipe in sizes 4" (100mm) through 12" (300mm). Direct assembly of CIOD pipes to these fittings should be made adhering to the principles given in the previous sections and with reference to the following diagrams. These fittings are supplied with the sealing gasket inserted in the bells. Only manual effort should be used to assemble PVC fittings. Special transition gaskets allow IPS O.D. pipe to be used with IPEX Blue Brute fittings. Sealing gaskets supplied for these fittings are not interchangeable with the gaskets supplied for other pipes and fittings.

NOTE: *Factory-made assembly lines on the pipe do not indicate correct assembly to fittings.*

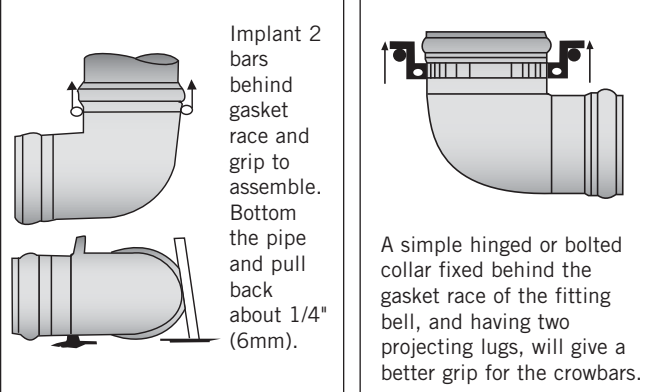

Implant 2 bars behind gasket race and grip to assemble. Bottom the pipe and pull back about 1/4" (6mm).

A simple hinged or bolted collar fixed behind the gasket race of the fitting bell, and having two projecting lugs, will give a better grip for the crowbars.

Dimensional Data

Below are the exterior dimensions for each of the Blue Brute molded fittings available from IPEX.

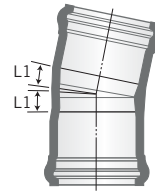

11-1/4° Elbow

Nominal Size		L1	
in	mm	in	mm
4	100	3.0	75
6	150	0.8	20
8	200	0.9	23

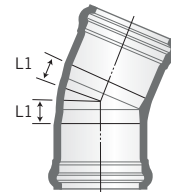

22-1/2° Elbow

Nominal Size		L1	
in	mm	in	mm
6	150	1.0	25
8	200	1.1	28
10	250	1.7	43
12	300	1.9	48

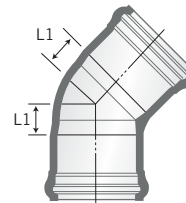

45° Elbow

Nominal Size		L1	
in	mm	in	mm
4	100	1.3	33
6	150	1.8	46
8	200	2.2	56
10	250	2.7	70
12	300	3.2	82

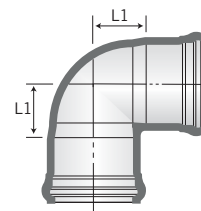

90° Elbow

Nominal Size		L1	
in	mm	in	mm
4	100	2.6	67
6	150	4.3	108
8	200	5.5	140
10	250	6.7	171
12	300	7.7	195



Tee

Nominal Size		L1		L2		L3		L4	
in	mm	in	mm	in	mm	in	mm	in	mm
4 x 4 x 4	100 x 100 x 100	2.6	67	2.6	67	-	-	-	-
6 x 6 x 4	150 x 150 x 100	4.0	102	3.3	87	-	-	-	-
6 x 6 x 6	150 x 150 x 150	4.3	108	4.3	108	-	-	-	-
8 x 8 x 4	200 x 200 x 100	5.1	130	3.6	91	-	-	-	-
8 x 8 x 6	200 x 200 x 150	5.3	136	4.7	120	-	-	-	-
8 x 8 x 8	200 x 200 x 200	5.6	143	5.8	148	-	-	-	-
10 x 10 x 4	250 x 250 x 100	6.7	171	6.7	171	11.2	284	27.3	693
10 x 10 x 6	250 x 250 x 150	6.7	171	6.7	171	12.0	305	27.3	693
10 x 10 x 8	250 x 250 x 200	6.7	171	6.7	171	12.8	325	27.3	693
10 x 10 x 10	250 x 250 x 250	6.7	171	6.7	171	13.7	348	27.3	693
12 x 12 x 4	300 x 300 x 100	7.7	195	7.7	195	12.1	307	30.5	775
12 x 12 x 6	300 x 300 x 150	7.7	195	7.7	195	12.9	328	30.5	775
12 x 12 x 8	300 x 300 x 200	7.7	195	7.7	195	13.7	348	30.5	775
12 x 12 x 10	300 x 300 x 250	7.7	195	7.7	195	14.6	371	30.5	775
12 x 12 x 12	300 x 300 x 300	7.7	195	7.7	195	15.3	389	30.5	775

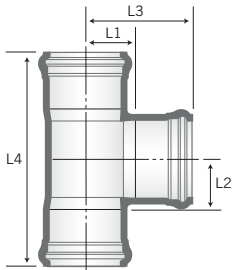

Hydrant Tee

Nominal Size		L1		L2		L3		L4	
in	mm	in	mm	in	mm	in	mm	in	mm
6 x 6 x 6	150 x 150 x 150	4.5	114	3.8	96	11.5	292	17.0	457
8 x 8 x 6	200 x 200 x 150	5.8	148	5.2	132	12.8	312	22.4	569
10 x 10 x 6	250 x 250 x 150	7.0	178	6.7	171	14.0	356	27.3	693
12 x 12 x 6	300 x 300 x 150	8.1	206	7.7	195	15.1	384	30.5	775

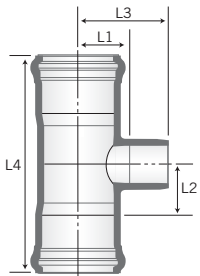

Reducing Adapter (Spigot x Bell)

Nominal Size		L1		L2	
in	mm	in	mm	in	mm
6 x 4	150 x 100	5.6	141	4.3	108
8 x 6	200 x 150	6.5	165	5.7	145
10 x 8	250 x 200	7.0	178	5.8	147
12 x 10	300 x 250	7.9	202	6.6	167

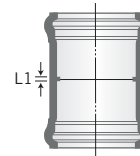

Coupling

(available w/o center stop as a Repair Coupling)

Nominal Size		L1	
in	mm	in	mm
4	100	0.2	5
6	150	0.3	8
8	200	0.3	7
* 10	250	0.5	13
* 12	300	0.5	13

* One-piece machined coupling.

Note: 3/4" (20mm) Taps to 2" (50mm),

Taps: AWWA Thread



Single Tapped Coupling

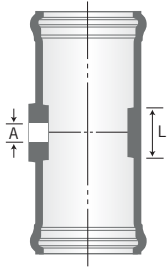

Nominal Size		A		L	
in	mm	in	mm	in	mm
4 x 4 x 3/4	100 x 100 x 20	3/4	20	2.0	50
4 x 4 x 1	100 x 100 x 25	1	25	2.0	50
6 x 6 x 3/4	150 x 150 x 20	3/4	20	3.0	76
6 x 6 x 1	150 x 150 x 25	1	25	3.0	76
6 x 6 x 1-1/4	150 x 150 x 32	1-1/4	32	3.0	76
6 x 6 x 1-1/2	150 x 150 x 40	1-1/2	40	3.0	76
8 x 8 x 3/4	200 x 200 x 20	3/4	20	3.0	76
8 x 8 x 1	200 x 200 x 25	1	25	3.0	76
8 x 8 x 1-1/4	200 x 200 x 32	1-1/4	32	3.0	76
8 x 8 x 1-1/2	200 x 200 x 40	1-1/2	40	3.0	76
8 x 8 x 2	200 x 200 x 50	2	50	3.0	76
* 10 x 10 x 3/4	250 x 250 x 20	3/4	20	3.0	76
* 10 x 10 x 1	250 x 250 x 25	1	25	3.0	76
* 12 x 12 x 3/4	300 x 300 x 20	3/4	20	3.0	76
* 12 x 12 x 1	300 x 300 x 25	1	25	3.0	76

* One-piece machined coupling.
 Note: 3/4" (20mm) Taps to 2" (50mm),
 Taps: AWWA Thread

Double Tapped Coupling

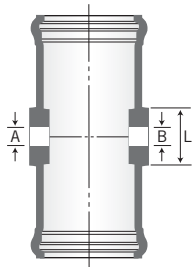

Nominal Size		A		B		L	
in	mm	in	mm	in	mm	in	mm
6 x 3/4 x 3/4	150 x 20 x 20	3/4	20	3/4	20	3.0	76
6 x 1 x 3/4	150 x 25 x 20	3/4	20	1	25	3.0	76
6 x 1 x 1	150 x 25 x 25	1	25	1	25	3.0	76
6 x 1-1/4 x 3/4	150 x 32 x 20	3/4	20	1-1/4	32	3.0	76
6 x 1-1/4 x 1	150 x 32 x 25	1	25	1-1/4	32	3.0	76
6 x 1-1/2 x 3/4	150 x 40 x 20	3/4	20	1-1/2	40	3.0	76
6 x 1-1/2 x 1	150 x 40 x 25	1	25	1-1/2	40	3.0	76
6 x 2 x 3/4	150 x 50 x 20	3/4	20	2	50	3.0	76
6 x 2 x 1	150 x 50 x 25	1	25	2	50	3.0	76
8 x 3/4 x 3/4	200 x 20 x 20	3/4	20	3/4	20	3.0	76
8 x 1 x 3/4	200 x 25 x 20	3/4	20	1	25	3.0	76
8 x 1 x 1	200 x 25 x 25	1	25	1	25	3.0	76
8 x 1-1/4 x 3/4	200 x 32 x 20	3/4	20	1-1/4	32	3.0	76
8 x 1-1/4 x 1	200 x 32 x 25	1	25	1-1/4	32	3.0	76
8 x 1-1/2 x 3/4	200 x 40 x 20	3/4	20	1-1/2	40	3.0	76
8 x 1-1/2 x 1	200 x 40 x 25	1	25	1-1/2	40	3.0	76
8 x 2 x 3/4	200 x 50 x 20	3/4	20	2	50	3.0	76
8 x 2 x 1	200 x 50 x 25	1	25	2	50	3.0	76

Note: 3/4 inch (20mm) Taps to 2 inch (50mm)
 Taps: AWWA Thread



High Deflection Couplings

Nominal Size		L1	
in	mm	in	mm
10	250	3.5	89
12	300	3.5	89

Plug

Nominal Size		L1	
in	mm	in	mm
4	100	6.5	164
6	150	7.8	198
8	200	9.1	231
10	250	10.2	258
12	300	9.8	249

Tapped Plugs (I.P.S. threads)

Nominal Size		L1	
in	mm	in	mm
4 x 3/4	100 x 20	6.5	164
4 x 1	100 x 25	6.5	164
4 x 1-1/2	100 x 40	6.5	164
4 x 2	100 x 50	6.5	164
6 x 3/4	150 x 20	7.8	198
6 x 1	150 x 25	7.8	198
6 x 1-1/2	150 x 40	7.8	198
6 x 2	150 x 50	7.8	198
8 x 3/4	200 x 20	9.1	231
8 x 1	200 x 25	9.1	231
8 x 1-1/2	200 x 40	9.1	231
8 x 2	200 x 50	9.1	231

IPS INJECTION MOLDED PVC FITTINGS**Introduction**

Cycle Tough gasketed PVC pressure fittings with IPS O.D. (equivalent to steel pipe outside diameters) are available in sizes ranging from 1-1/2" (38mm) through 24" (600mm). Sizes 1-1/2" (38mm) through 8" (200mm) are certified to CSA B137.3 while larger sized fabricated fittings are also available CSA certified. Cycle Tough injection molded fittings and are manufactured with a PVC compound having an HDB of 4000 psi - the same as the pipe. These fittings cannot be used directly on CIOD pipe but may be adapted to C900 or C909 pipe by using transition adapters. These adapters are available with either spigot or bell ends and are approximately 24" (600mm) long.

Injection molded Cycle Tough fittings are equipped with specialized gaskets that cannot be easily switched to the nitrile gasket option. If you have a Cycle Tough installation that requires oil-resistant gaskets, contact your IPEX representative. Do not attempt to substitute standard pipe gaskets in these fittings in the field.

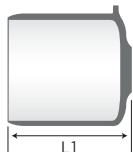
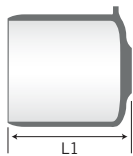

Engineered Joint

Cycle Tough fittings have a unique sealing system. The engineered joint is designed to withstand thousands of pressure cycles while providing a bottle tight joint. Some of the features of this unique pressure gasket system include:

1. Pressure pockets that transmit internal water pressure to the pipe spigot making a tight leakproof seal.
2. Second sealing lip creates a tight seal having ample sealing tolerance for pipes with nominal diameters.
3. High impact and high memory polypropylene lock rings prevent gasket movement from the raceway during assembly and normal pressure conditions.
4. The first smaller lip prevents foreign material from coming in contact with second sealing lip. It also centralizes the pipe spigot while at the same time preventing contact with the lock ring.
5. Massive rubber area with a low compression set for outstanding compression seal.
6. An arched back pocket gives excellent tolerance to the gasket seat raceway. This transmits an even radial force from the lock ring to the gasket seat.
7. The gasket is completely injection molded (including color coded polypropylene lock ring) for better tolerance and dimension control.

Joint Cutaway

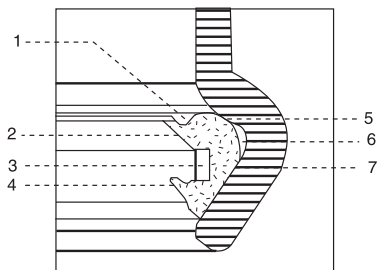

Dimensional Data

Below are the exterior dimensions for each of the Cycle Tough molded fittings available from IPEX.

45° Elbow (G x G)

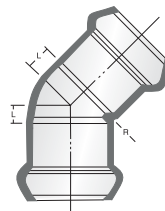

Nominal Size		L		R	
in	mm	in	mm	in	mm
2	50	0.6	15	0.8	19
2-1/2	65	1.8	45	1.0	25
3	75	1.1	28	1.0	25
4	100	1.1	28	1.0	25
6	150	1.6	40	1.3	31
8	200	2.4	60	1.5	38

90° Elbow (G x G)

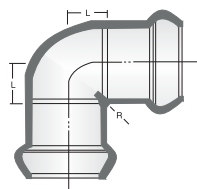

Nominal Size		L		R	
in	mm	in	mm	in	mm
2	50	1.2	30	0.8	19
2-1/2	65	1.8	45	1.0	25
3	75	2.0	50	1.0	25
4	100	2.2	55	1.0	25
6	150	2.8	70	1.3	31
8	200	4.9	122	1.5	38

Tee (G x G x G)

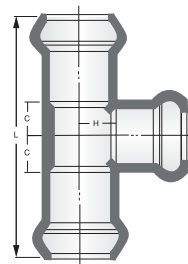

Nominal Size		C		H		L	
in	mm	in	mm	in	mm	in	mm
2	50	1.3	33	1.1	28	7.6	190
2-1/2	65	1.7	42	1.6	41	9.5	238
3	75	2.0	50	2.0	50	10.8	270
4	100	2.8	64	2.7	66	12.5	313
6	150	3.8	94	3.8	94	14.9	373
8	200	4.9	123	4.9	123	21.7	541



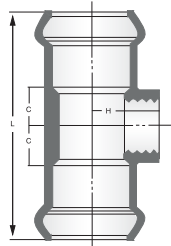

Tap Service Tee (NPT Outlet)

Nominal Size		C		H		L	
in	mm	in	mm	in	mm	in	mm
2 x 1/2	50 x 15	1.4	35	2.2	54	7.1	178
2 x 3/4	50 x 20	1.4	35	2.2	54	7.1	178
2 x 1	50 x 25	1.4	35	2.2	54	7.1	178
2 x 1-1/4	50 x 32	1.4	35	2.2	54	7.1	178
2 x 1-1/2	50 x 40	1.4	35	2.2	54	7.1	178
2-1/2 x 1/2	65 x 15	1.5	36	2.5	63	7.9	198
2-1/2 x 3/4	65 x 20	1.5	36	2.5	63	7.9	198
2-1/2 x 1	65 x 25	1.5	36	2.5	63	7.9	198
2-1/2 x 1-1/4	65 x 32	1.5	36	2.5	63	7.9	198
2-1/2 x 1-1/2	65 x 40	1.5	36	2.5	63	7.9	198
2-1/2 x 2	65 x 50	1.5	36	2.5	63	7.9	198
3 x 1/2	75 x 15	1.5	38	2.7	68	9.8	244
3 x 3/4	75 x 20	1.5	38	2.7	68	9.8	244
3 x 1	75 x 25	1.5	38	2.7	68	9.8	244
3 x 1-1/4	75 x 32	1.5	38	2.7	68	9.8	244
3 x 1-1/2	75 x 40	1.5	38	2.7	68	9.8	244
3 x 2	75 x 50	1.5	38	2.7	68	9.8	244
4 x 1/2	100 x 15	1.6	39	3.1	78	10.2	254
4 x 3/4	100 x 20	1.6	39	3.1	78	10.2	254
4 x 1	100 x 25	1.6	39	3.1	78	10.2	254
4 x 1-1/4	100 x 32	1.6	39	3.1	78	10.2	254
4 x 1-1/2	100 x 40	1.6	39	3.1	78	10.2	254
4 x 2	100 x 50	1.6	39	3.1	78	10.2	254
6 x 1/2	150 x 15	1.8	45	4.0	99	13.0	325
6 x 3/4	150 x 20	1.8	45	4.0	99	13.0	325
6 x 1	150 x 25	1.8	45	4.0	99	13.0	325
6 x 1-1/4	150 x 32	1.8	45	4.0	99	13.0	325
6 x 1-1/2	150 x 40	1.8	45	4.0	99	13.0	325
6 x 2	150 x 50	1.8	45	4.0	99	13.0	325

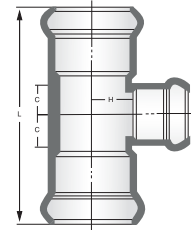

Reducing Tee (G x G x G)

Nominal Size		C		H		L	
in	mm	in	mm	in	mm	in	mm
2 x 1-1/2	50 x 40	1.3	33	1.1	28	7.6	190
2-1/2 x 2	65 x 50	1.8	42	1.6	41	9.5	238
3 x 1-1/2	75 x 40	1.9	46	1.6	40	10.8	270
3 x 2	75 x 50	1.9	46	1.6	40	10.8	270
3 x 2-1/2	75 x 65	1.9	48	1.6	40	10.8	270
4 x 2	100 x 50	1.9	48	2.0	50	11.3	283
4 x 2-1/2	100 x 65	1.9	48	2.0	50	11.3	283
4 x 3	100 x 75	1.9	48	2.0	50	11.3	283
6 x 2	150 x 50	2.4	60	2.8	70	14.9	373
6 x 2-1/2	150 x 65	2.4	60	2.8	70	14.9	373
6 x 3	150 x 75	2.4	60	2.8	70	14.9	373
6 x 4	150 x 100	2.4	60	2.8	70	14.9	373
8 x 2	200 x 50	3.9	96	4.9	122	19.5	488
8 x 3	200 x 75	3.9	96	4.9	122	19.5	488
8 x 4	200 x 100	3.9	96	4.9	122	19.5	488
8 x 6	200 x 150	3.9	96	4.9	122	19.5	488

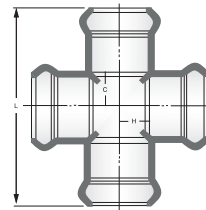

Cross (G x G x G)

Nominal Size		C		H		L	
in	mm	in	mm	in	mm	in	mm
4	100	4.0	100	4.0	100	12.5	313
6	150	4.5	113	4.5	113	16.0	400



Stop Coupling (G x G)

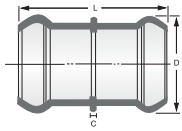

Nominal Size		L		D	
in	mm	in	mm	in	mm
2	50	5.0	125	3.4	84
2-1/2	65	7.1	179	4.2	104
3	75	7.0	175	5.0	125
4	100	7.4	185	6.1	153
6	150	10.0	250	8.7	218
8	200	12.3	308	10.6	266

Repair Coupling (G x G)

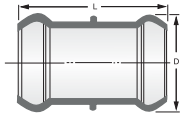

Nominal Size		L		D	
in	mm	in	mm	in	mm
2	50	7.2	180	3.4	84
2-1/2	65	7.0	175	4.2	104
3	75	7.0	175	5.0	125
4	100	7.4	185	6.1	153
6	150	10.0	250	8.7	218
8	200	12.3	308	10.6	266

Permanent Plug Spigot

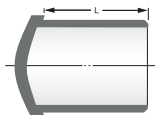

Nominal Size		L	
in	mm	in	mm
1-1/2	40	2.5	63
2	50	2.5	63
2-1/2	65	3.5	88
3	75	3.5	88
4	100	3.8	94
6	150	4.5	113

Increaser Bushing (G x Sp)

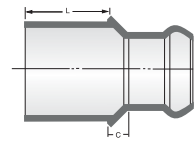

Nominal Size		L		D	
in	mm	in	mm	in	mm
1-1/2 x 2	40 x 50	2.4	60	0.2	5
2 x 2-1/2	50 x 65	2.4	60	0.2	5
2 x 3	50 x 75	3.4	85	0.6	14
2-1/2 x 3	65 x 75	3.4	85	0.4	10
2 x 4	50 x 100	3.0	75	0.4	10
2-1/2 x 4	65 x 100	3.0	75	0.4	10
3 x 4	75 x 100	3.0	75	0.4	10
2 x 6	50 x 150	4.3	108	0.5	13
2-1/2 x 6	65 x 150	4.3	108	0.5	13
3 x 6	75 x 150	4.3	108	0.5	13
4 x 6	100 x 150	4.3	108	0.5	13
4 x 8	100 x 200	5.1	128	0.6	15
6 x 8	150 x 200	5.1	128	0.6	15

Adapter (Flange x Gasket Bell)

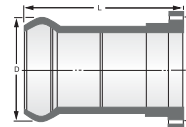

Nominal Size	C		D		L		
in	mm	in	mm	in	mm	in	mm
1-1/2	40	3.9	96	5.0	125	4.3	106
2	50	4.8	119	6.0	150	4.8	119
2-1/2	65	5.5	138	7.0	175	5.8	144
3	75	6.0	150	7.5	188	6.5	163
4	100	7.5	187	9.0	226	10.5	263
6	150	9.6	239	11.0	274	13.5	337
8	200	11.8	294	13.5	338	12.0	300

Spigot Adapter (G x Sp)

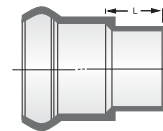

Nominal Size		L	
in	mm	in	mm
1-1/2	40	1.5	38
2	50	1.8	45
2-1/2	65	2.0	50
3	75	2.1	53
4	100	2.3	58
6	150	3.1	78

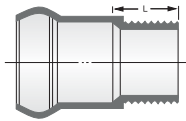

Male Adapter (G x Male Pipe Thread)

Nominal Size		L	
in	mm	in	mm
1-1/2	40	1.1	26
2	50	1.2	30
2-1/2	65	1.6	39
3	75	2.1	53
4	100	2.3	56
6	150	2.5	63

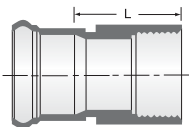
Adapter (Bell x Female IPT)

Nominal Size		L	
in	mm	in	mm
1-1/2	40	2.6	65
2	50	3.0	75
2-1/2	65	3.8	95
3	75	4.1	103
4	100	4.4	110
6	150	5.4	135

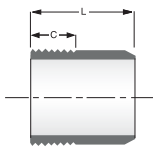
Adapter (PE (Plain End) x Male Pipe Thread)

Nominal Size		L		C	
in	mm	in	mm	in	mm
3	75	4.3	108	2.0	50
4	100	4.4	110	2.3	56
6	150	5.9	148	2.5	63

FABRICATED PVC PRESSURE FITTINGS

For all sizes of PVC pressure pipes with either CIOD or IPS outside diameters, fittings may be fabricated from welded pipe segments and fiberglass-reinforced polyester overwrap construction. These fittings have the same gasketed bell joint that is used with the pipe.

BIONAX® SR™ SEISMIC RESISTANT PVC WATER PIPE

Bionax SR pipe is designed to survive significant seismic events and permanent ground deformation. It is CSA and AWWA approved PVC pipe with lengthened bell ends that, when properly restrained, allow the pipeline to extend in a chain-like fashion. In addition to its unique joints, Bionax SR pipe is able to stretch, compress and bend like no other pipe in existence.

It is the combination of the bell design and material properties that make Bionax SR the ideal choice for projects in areas that are vulnerable to seismic activity.

Dimensions

Please reference dimensional information on page 22 of this guide.

Joint Assembly

Bionax SR joints should be assembled in the same way as standard Bionax PVC. This installation procedure is outlined in pages 11-13 of this guide. If there is no insertion line, it should be marked as follows:

Nominal Size		Insertion Line Depth	
mm	in	mm	in
150	6	195	7.68
200	8	235	9.25
250	10	245	9.65
300	12	305	12.01

Note: These insertion lines are not applicable when installing with fittings or standard bell Bionax.



Restrainers

It is common to restrain all pipe joints in areas at risk of seismic activity and permanent ground deformation. However, to maximize the efficacy of Bionax SR to absorb pipeline strain, joint restraints which allow for some joint opening before engaging are desirable. When installed properly, Bionax SR joints are designed to maintain a seal after the joints have opened as described in the table below.

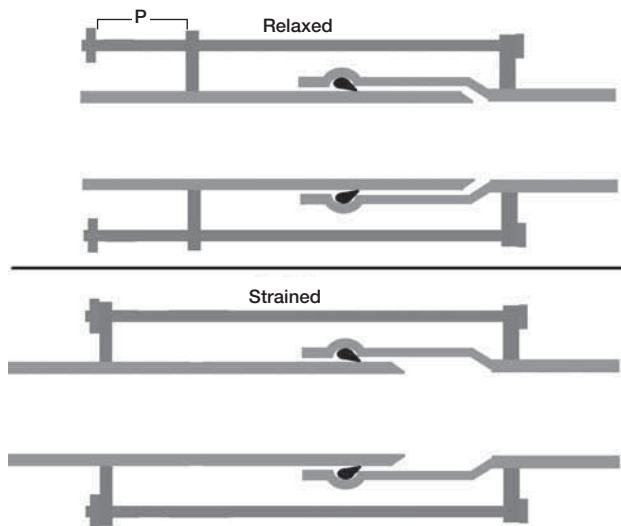

Nominal Size		Maximum Joint Pull (P)	
mm	in	mm	in
150	6	76.2	3
200	8	76.2	3
250	10	76.2	3
300	12	101.6	4

Installing these restrainers will be different than standard joint restraints. Always make sure to follow the manufacturer's installation instructions carefully. Standard joint restraints or thrust blocks should be used when there are thrust forces caused by the pipeline configuration. Requirements for this scenario are described on pages 47 – 51 of this guide.

TERRABRUTE® CR TRENCHLESS APPLICATIONS

TerraBrute® CR is an integral bell restrained joint PVC pipe. It is AWWA C900 pipe with slight modification that allows the joints to be locked, and the pipe used for “pulled in place” applications like horizontal directional drilling (HDD), pipe bursting or slip lining



TerraBrute CR's patented locking system allows pipe to be assembled one length at a time, thus minimizing disturbance to the surrounding area and making TerraBrute CR the ideal choice for HDD projects located in tight areas.

Dimensions

When planning a project with TerraBrute CR, it must be remembered that it is a gasketed cast iron outside diameter (CIOD) pipe. The bell is the largest diameter on the pipe and must be accounted for.

Dimensions

Nominal Diameter		Pressure Class/Rating (2:1 safety factor)	Maximum OD (Bell OD)		Average ID	
mm	in		mm	in	mm	in
100	4	305	165	6.49	104	4.09
150	6	305	230	9.06	149	5.87
200	8	235	288	11.33	204	8.03
250	10	235	355	14.00	250	9.84
300	12	235	416	16.36	297	11.69



Maximum Allowable Bending - TerraBrute® CR Pipe

Nominal Size		Allowable Pipe Bending Angle (Degrees)	Allowable Pipe & Joint Deflection (Degrees)	Total
mm	in			
100	4	5.7	8.5	14.2
150	6	4	8.5	12.5
200	8	3	7.5	10.5
250	10	2.5	5	7.5
300	12	2.1	5	7.1

Joint Assembly Instructions

The TerraBrute CR locking mechanism has been designed for easy installation. In fact, it is not much different from assembling a standard C900 joint.

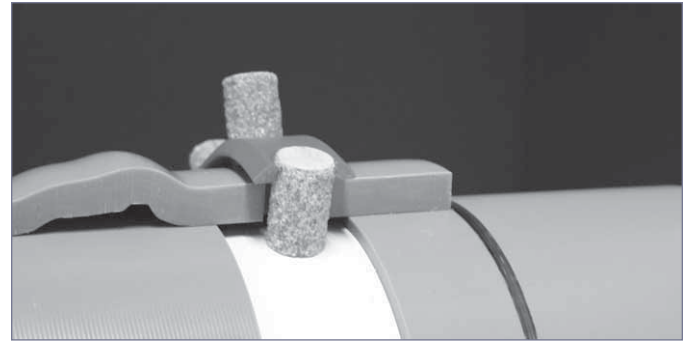

General Recommendations:

Pipe joints should be assembled using manual effort wherever possible. However if mechanical assistance is required, a pipe stop should be used to prevent over insertion. This can be easily accomplished by installing a standard restrainer grip ring or a clamp aligned with the insertion line on the spigot.

- 1 Locate the insertion line on the spigot end of each pipe. If the line is missing, it can be marked as follows. (see chart below)

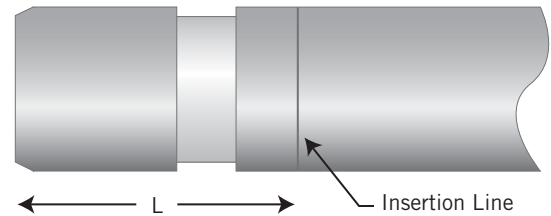

Pipe Size		Insertion Line Depth (L)	
mm	in	mm	in
100	4	195	7.7
150	6	218	8.6
200	8	253	10.0
250	10	268	10.6
300	12	293	11.5

Joint Deflection Radius & Minimum Allowable Radius

Joint Deflection Radius *		Min. Allowable Radius **	
m	ft	m	ft
40.4	132.7	24.2	79.4
40.4	132.7	27.5	90.2
45.8	150.3	32.7	107.4
68.8	225.5	45.8	150.3
68.8	225.5	48.4	158.8

* Bending radius with joint deflection only (no bending)

** Joint deflection and pipe bending

Maximum Allowable Pull Force

Nominal Size		Allowable* Pulling Force	
mm	in	kN	lbs
100	4	50	11200
150	6	110	24700
200	8	115	25800
250	10	187.5	42100
300	12	275	61800

*Using a 2:1 Safety Factor



- 2 Lube the spigot and gasket as you normally would when assembling a standard C900 joint.
- 3 Using a bar and block for smaller sizes (4" - 8" (100mm - 200mm)) or mechanical means for larger sizes, line up the two pipes in a straight line and push the spigot into the bell. The pipe should be pushed until the line marked on the spigot is aligned with the end of the bell. Care must be taken not to over-insert the pipe as the locking pins may not line up with the inner groove.

While this can be easily controlled when using manual effort, it can be more difficult when using mechanical means such as a backhoe. In these cases it is recommended that a "pipe stop" be installed on the insertion line to prevent over-insertion. A standard restrainer ring that can be removed after assembly will accomplish this.



- 4 Once the holes on the bell are aligned with the inner groove, line up the pins on the external half ring with the holes in the bell so that the half ring covers either the left or right side of the pipe.

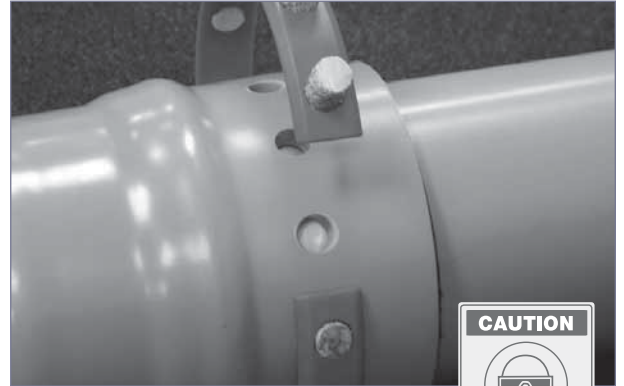

****SAFETY GLASSES MUST BE WORN DURING PIN INSTALLATION.**



- 5 Using a 1 lb hammer, tap in the pins starting at the top of the pipe working your way down. The pins should be tapped until they bottom out on the inner groove or are flush with the ring. A good technique to ensure proper alignment is to tap each pin on the ring 1/4 to 1/2 of the way in before hammering in fully. **If the pins will not go all the way in, check to see if the rings, holes, and inner groove are properly aligned on all sides.**

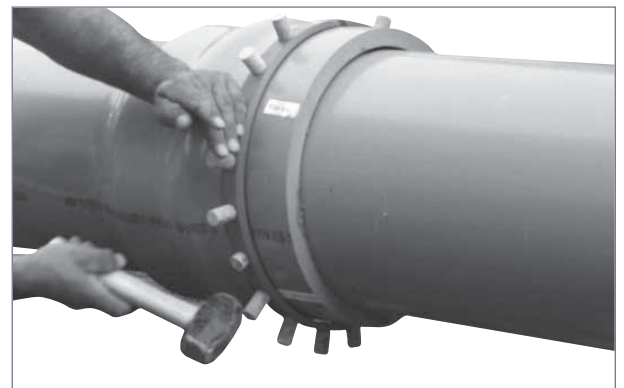

- 6 Check to make sure all of the pins are fully inserted before starting the next joint.



ATTENTION

Ensure the inner groove is completely aligned with holes before inserting pins. All pins must be bottomed out on the inner groove after insertion.

When connecting to standard C900 pipe or fittings, cut off grooved portion and chamfer pipe edges as shown in the Installation Manual. **DO NOT** use the TerraBrute CR insertion mark as a guide for insertion into standard pipe or fittings – it is designed for the extended bell of TerraBrute CR.

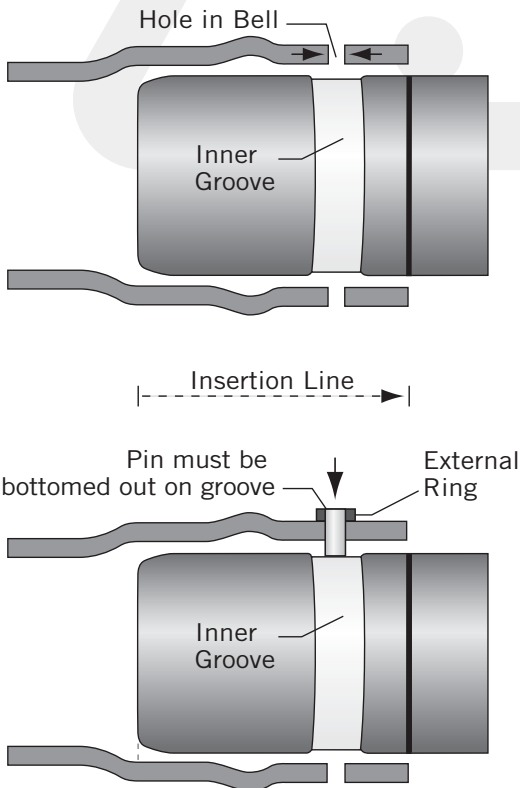

RESISTING THRUST AT FITTINGS AND VALVES

Introduction

At many locations in a pressurized pipeline, an imbalance in hydrostatic forces may occur as a result of the pipeline configuration. These unbalanced forces are called thrust forces. Thrust forces can occur at any point in a piping system where the direction or cross-sectional area of the waterway changes. Pipeline installers must balance these forces by means of thrust blocks or mechanical restraint. Three areas that require restraint are described below.

• At Valves

All valves must be anchored. This includes valves installed in a chamber or in line with the pipe, whether it is operated frequently or only once a year.

Install anchor rods around the valve body or through the mounting lugs and embed the rods in a concrete pour beneath the valve. Valves installed in chambers must also be anchored in this fashion. The critical time for restraint of valves is during opening or closing.

• At Changes in Direction (Vertical or Horizontal)

Fittings such as elbows, tees, or dead ends, must be restrained since they involve a significant directional change for the fluid.

• At Reductions in Size

The thrust component at reductions in size will depend on the amount of the reduction, and must be adequately restrained.

At each point in the line where thrust forces will develop, pour a concrete block between the fitting and undisturbed native soil at the side of the trench. Use plywood sheets to form the block and control the pour so that the area of contact with the undisturbed trench will provide the necessary support.

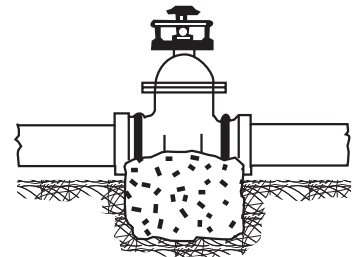

Bearing Strength of Undisturbed Soils

These soil bearing capacities are approximate and conservative. For greater design precision IPEX recommends that soil bearing tests be carried out by a competent soils engineer.

Organic Material (such as Peat, etc.)	0 lb/ft ²
Soft Clay	500 lb/ft ²
Sand	1000 lb/ft ²
Sand and Gravel	1500 lb/ft ²
Sand and Gravel with Clay	2000 lb/ft ²
Sand and Gravel Cemented with Clay	4000 lb/ft ²
Hard Pan	5000 lb/ft ²

The recommended bearing area to be established by the concrete pour may be given by the engineer. The area (ft.²) may also be calculated by determining the total thrust generated at the fitting. Simply divide the bearing strength of the soil into the thrust developed (lbs force), as found in the accompanying table. The result is the area of the soil required to resist the thrust (A). The area calculated will be for the area of concrete up against the trench wall (i.e. the back side of the block).

NOTE: *Pre-cast thrust blocks should not be placed directly against PVC fittings.*

Resisting Thrust in Very Poor Soils

Where the pipeline passes through soils having little or no bearing strength, thrust forces may be restrained by the encasement of the fitting in concrete and the extension of this pour to form a monolith having sufficient inertia to resist the thrusts. It may also be possible to loop tie rods around the fitting and anchor the tie rods into an upstream concrete pour across the trench in more stable soils. Mechanical thrust restraints may also be used in these cases.

Thrust Developed per 100 psi pressure (lbs. force)

Pipe Diameter		Valves & Dead Ends, Tees	90° Bends	45° Bends	221/2° Bends	111/4° Bends
in	mm					
4	100	1810	2560	1390	635	320
6	150	3740	5290	2860	1370	690
8	200	6430	9100	4920	2320	1170
10	250	9680	13680	7410	3610	1820
12	300	13690	19350	10470	5080	2550
14	350	18380	25990	14100	6100	3080
16	400	23780	33630	18280	7960	4020
18	450	29860	42230	22970	10060	5080
20	500	36640	51820	28180	12440	6280
24	600	52280	73930	40200	17940	9060
30	750	80425	113737	61557	31500	15800
36	900	115200	162929	88181	45000	22600
42	1050	155500	219950	119000	60700	30500
48	1200	202700	286700	155200	79000	39800
54	1350	260100	367696	199059	101979	50985
60	1500	298000	421393	228056	116262	58412

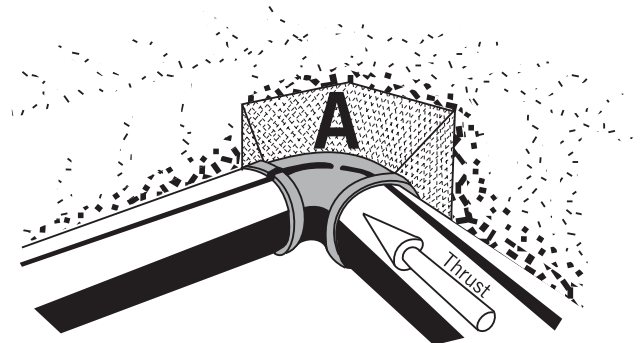

$$\text{area A} = \frac{\text{Thrust Force}}{\text{Bearing Strength of Soil}}$$



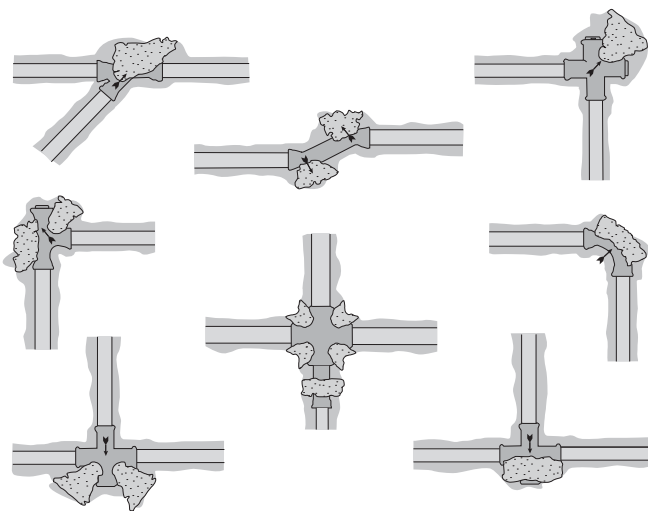

Typical thrust block locations. Trim the trench bearing area using hand tools to be sure of undisturbed soil.

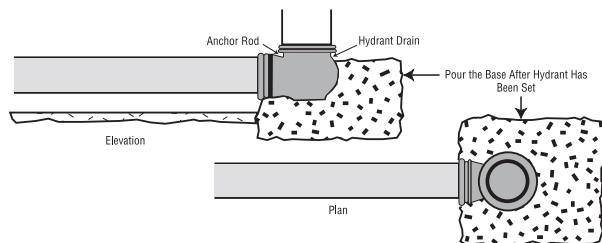

This type of hydrant foundation acts as a thrust-block, as an anchorage against frost heave and eliminates washouts from waste-water drain.

Resisting Vertical Thrust

Where the pipeline will change direction downwards to pass under a creek bed or roadway, etc., upward thrust will be developed at the fitting. Anchor the fitting as though it were a valve, and ensure that the concrete base is keyed into undisturbed soil.

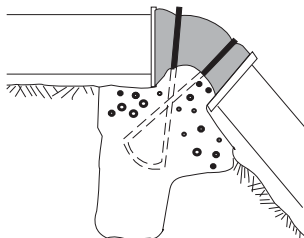

Straps should be 2" (50 mm) wide or greater.

Holding Pipe to Steep Slopes

Normal bedding practices for pipelines installed up a hill will be sufficient to prevent backsliding and decoupling where the slope is greater than 20° (36% slope). When the height of cover is less than 6 feet (1.8 m) and the soil conditions are marginal, a special anchoring method may be desirable. One recommended procedure is to lay the pipe with the bells facing uphill and pour a concrete block behind the bells and keyed into the undisturbed trench sidewalls. Usually every third length of pipe will need to be anchored in this fashion to achieve a stable condition. The use of solvent welded joints for short sections of the pipeline may also be considered on steep slopes.

Mechanical Thrust Restraints

Several mechanical thrust restraint devices are available which clamp to the wall of the pipe and tie back to a mating collar on the fitting or the pipe bell. The use of these devices may provide the entire thrust restraint necessary at the fitting, in sizes up to 48 inches (1200 mm). The use of several thrust restraints to tie together two or three lengths of pipe on either side of the fitting may be required.

When a thrust restraint device is used the maximum pressure in the pipeline (usually the test pressure) must not exceed the pressure rating of the device.

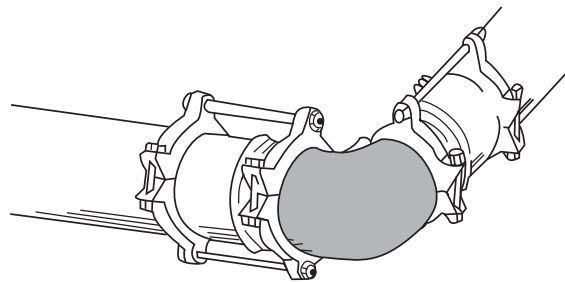

Flanged Joints

PVC pipe may be connected to flanged joints by using a flange adapter. As is the case regardless of pipe material, flanged joints are not recommended for buried underground installations except inside a valve chamber.



RECOMMENDED TAPPING AND SERVICE CONNECTIONS

In addition to the use of IPEX Tapped Couplings (see Blue Brute Fittings Brochure) there are other methods for making service connections to PVC and PVC0 pressure pipes. Check with your local municipality to see which methods are approved for your project:

Direct Tapping

This method is suitable only for PVC pipe sizes 6" (150mm), 8" (200mm), 10" (250mm), and 12" (300mm), conforming to AWWA C900 and CSA B137.3. Sizes 14" (350mm) and 16" (400mm) may also be direct tapped for DR25 and DR18 only. This method is not suitable for 4" (100mm) diameter or smaller pipe, or for 18" (450mm) and larger. In certain designated areas, where special provisions have been made, the above size restrictions may be modified. Consult IPEX.

There are no cold weather limitations for the tapping of PVC pipe products.

For a complete guide on tapping PVC pipe, ask for our comprehensive booklet entitled, "How to Tap Blue Brute Pipe". Also available is a video called "Tapping PVC Pressure Pipe" by the Uni-Bell PVC Pipe Association. It is available through IPEX for only \$15.

This method is not suitable for Bionax PVC0 pipe conforming to AWWA C909 and CSA B137.3.1.

Service Saddles

Service saddles are suitable for use on all PVC and PVC0 pressure pipes, both IPS and CIOD, and are suitable for outlets up to 2" (50mm) size. Choose a saddle with a fully encircling 2" (50mm) or wider band or strap. With larger sizes there may be two or more straps. The strap width must not be less than 2" (50mm).

Tapping Sleeve and Valve

Suitable for making large taps in any PVC or PVC0 pressure pipe for which the sleeve is available, this method is suitable for making taps up to size on size.

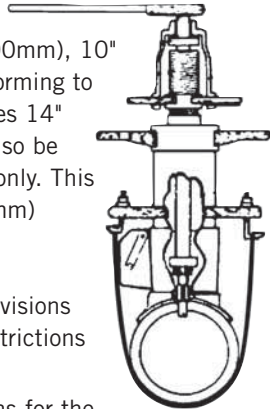

Tapping sleeves may be sufficiently specialized to warrant the services of an expert contractor who can provide the necessary equipment. Some precautions that are recommended include:

1. Make provision for support for the heavy components of the tapping sleeve and valve assembly.
2. This type of connection will generate thrust. Make sure the finished assembly has been adequately braced against the trench wall.
3. Sleeve manufacturers produce fittings for various outside diameters. Specify IPS or CIOD when ordering the sleeve.
4. Specify the pressure rating of the pipe when ordering. Where adequate thrust restraint is not available opposite the sleeve, provide an anchor for the valve.

Follow these procedures when making a sleeve tap:

1. Install the sleeve on the pipe to be tapped per the sleeve manufacturer's instructions. Tighten the mounting bolts to manufacturer's requirements. Over-tightened bolts can induce stress into the pipe being tapped. Failure to use lubrication on mat-type gaskets can induce stress into the pipe being tapped.
2. Attach the tapping valve to the tapping sleeve. The tapping valve is typically a specialty valve with a gasket-flanged connection to the outlet side and an MJ-type connection to the tapping machine side.
3. Support the tapping sleeve and valve independently from the pipe. Supports shall be left in place after tapping.
4. Attach the required PVC cutter and support hardware.
5. Attach the drilling machine to the tapping valve.
6. Install temporary supports under the tapping machine to support it independently from the pipe, sleeve, and valve.
7. Open the tapping valve.
8. Advance the cutter to the pipe being tapped.
9. Engage the cutter and cut the tapping hole. On power-operated tapping machines set the advance rate, the cutting rate, and the travel distance per manufacturer's recommendations. If using a hand-operated model, assure the proper advance rate, cutter rate and travel distance.
10. After the hole has been cut, retract the cutter, close the tapping valve, and remove the tapping machine.
11. Attach the new line.



Tapped Couplings



IPEX provides a simple solution for the elimination of saddles by offering PVC tapped couplings. These couplings accept standard corporation stops. For simultaneous service connections on both sides of the main, double tapped couplings are available.

To install, follow these steps:

- Step 1:** Inspect Tapped Couplings and ensure that interior of fittings and gaskets are free of dirt.
- Step 2:** Wrap the Teflon tape clockwise around the tapered inlet threads of the corporation stop. Make two complete wraps around the threads.
- Step 3:** Using a proper torque wrench, screw the corporation stop to a required torque between 35 ft. lbs. and 40 ft. lbs.
- Step 4:** Make sure the protective coupling nut is screwed on the outlet threads, and the valve is closed. Install Tapped Coupling in the trench with corporation stop positioned to receive the service connection.

THE TWO BACKFILLS & HAUNCHING

Haunching the material placed to the sides of the pipe from the bedding to about the springline (center line), is intended to help the pipe support the vertical loads. It is frequently a material with sizes not over 1-1/2" (38mm).

Initial Backfill

The material placed over the pipe itself to a height of 6 to 12" (150mm - 300mm) above the top of the pipe is the initial backfill. The maximum size of stone in the initial backfill, where not specified, should be 1-1/2" (38mm). Where it is not otherwise specified the initial backfill may consist of the native material in the trench provided it is free from large stones, not frozen, and free of debris or other organic materials. The purpose of the initial backfill is to protect the pipe from the final backfill.

Final Backfill

The material placed over the initial backfill to the top of the trench is the final backfill. If not otherwise specified the final backfill material may contain boulders up to 4" (100mm) in diameter and may consist of native material.

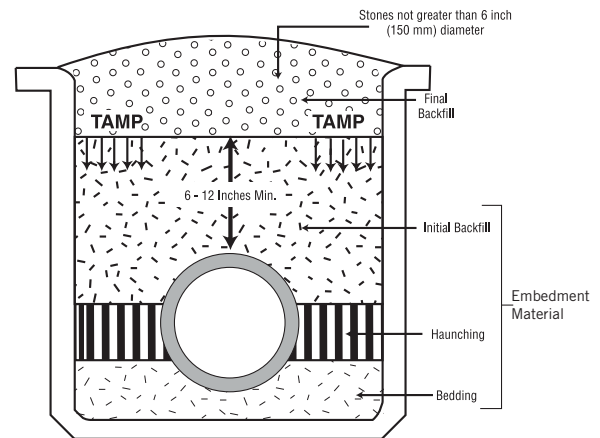

Compacting the Backfill

Compact the haunching, initial backfill and final backfill in accordance with the job drawings. Observe the following precautions.

1. When a "self-compacting" material is used, such as crushed stone, ensure that the material does not arch or bridge beneath the haunch of the pipe. Remove such voids with the tip of a spade.

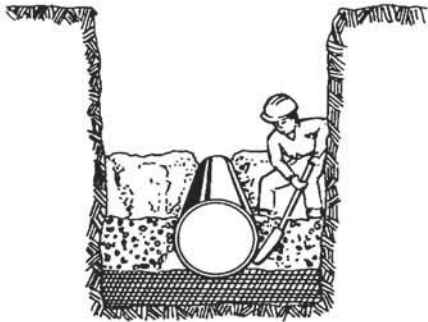

Get rid of voids under the pipe.

2. When compacting the material underneath and at either side of the pipe do not allow the tool or the machine to strike the pipe.
3. When compaction in excess of 85% standard proctor density is required in the haunching area ensure that the compacting effort does not dislodge the pipe from the correct grade. If the compacting effort dislodges the pipe, relay the pipe to the correct grade.
4. It is not necessary to compact the initial backfill directly over the top of the pipe for the sake of the pipe's structural strength. However, it may be necessary for the sake of roadway integrity.
5. A matrix of embedment materials can be successfully used with PVC pipe. Consult the following table for the expected deflection given a particular embedment material, compacted to a certain density.
6. As can be seen in the table on the following pages, at normal depths less than 16 ft. (4.9 m) of cover, compaction effort is used strictly to prevent trench settlement.

Shallow Bury Considerations

PVC pressure pipe (DR14, DR18, DR21, DR25, DR26, and DR32.5), Bionax PC235 pressure pipe, and PVC sewer pipe with a minimum pipe stiffness of 46 psi (DR35), may be buried with as little as 12 inches (300mm) of cover and be subjected to H-20 traffic loading. A minimum soil stiffness with an $E' = 1,000$ psi is recommended in the haunching and initial backfill of the trench for these conditions.

For PVC pressure and sewer pipe with a minimum pipe stiffness less than 46 psi (DR41 and DR51) and Bionax PR160 pressure pipe, a minimum cover of 24 inches is recommended with a minimum soil stiffness of $E' = 1,000$ psi in the haunching and initial backfill.

While it is not necessary to compact the backfill over the top of the pipe for the sake of the pipe's structural strength, it may be preferable to ensure the integrity of the road surface. Minimum recommended compaction requirements from the bottom of the trench to the underside of the road surface are 85% standard proctor density for rigid road surfaces and 95% standard proctor density for flexible road surfaces.



Percent % Deflection of BLUE BRUTE PIPE

ASTM Embedment Material Classification		Density AASHTO T-99	E' psi (kPa)	DR	Depth of Cover (feet)															
					1	2		4	6	8	10	15	20	25	30	35	40	45	50	
					% Deflection															
Manufactured Granular Angular	Class I	90%	3,000 (20 700)	25	0.7	0.5		0.3	0.3	0.4	0.4	0.6	0.8	1.0	1.2	1.4	1.6	1.9	2.1	
				18	0.6	0.4		0.3	0.3	0.3	0.4	0.5	0.7	0.9	1.1	1.2	1.4	1.6	1.6	1.8
				14	0.4	0.3		0.2	0.2	0.2	0.3	0.4	0.5	0.7	0.8	1.0	1.1	1.1	1.2	1.4
Clean Sand & Gravel	Class II	90%	2,000 (13 800)	25	1.0	0.7		0.4	0.5	0.5	0.6	0.9	1.2	1.5	1.8	2.1	2.4	2.7	2.9	
				18	0.8	0.5		0.4	0.4	0.4	0.5	0.7	0.9	1.2	1.4	1.7	1.9	2.1	2.1	2.4
				14	0.6	0.4		0.3	0.3	0.3	0.3	0.5	0.7	0.9	1.0	1.2	1.4	1.4	1.5	1.7
		80%	1,000 (7 000)	25	1.7	1.1		0.8	0.8	0.9	1.0	1.6	2.1	2.6	3.1	3.6	4.2	4.7	5.2	
				18	1.2	0.8		0.5	0.6	0.6	0.7	1.1	1.4	1.8	2.2	2.5	2.9	3.3	3.6	
				14	0.7	0.5		0.3	0.4	0.4	0.5	0.7	0.9	1.1	1.4	1.6	1.8	2.1	2.3	
Sand & Gravel with Fines	Class III	90%	1,000 (7 000)	25	1.7	1.1		0.8	0.8	0.9	1.0	1.6	2.1	2.6	3.1	3.6	4.2	4.7	5.2	
				18	1.2	0.8		0.5	0.6	0.6	0.7	1.1	1.4	1.8	2.2	2.5	2.9	3.3	3.6	
				14	0.7	0.5		0.3	0.4	0.4	0.5	0.7	0.9	1.1	1.4	1.6	1.8	2.1	2.3	
		85%	500 (3 500)	25	n/r	1.9		1.3	1.3	1.4	1.7	2.5	3.3	4.2	5.0	5.9	6.7	7.5	8.4	
				18	n/r	1.1		0.7	0.8	0.8	1.0	1.5	2.0	2.5	2.9	3.4	3.9	4.4	4.9	
				14	n/r	0.6		0.4	0.4	0.5	0.5	0.8	1.1	1.4	1.6	1.9	2.2	2.5	2.7	
Silt & Clay	Class IV	85%	400 (2 760)	25	n/r	2.1		1.4	1.5	1.6	1.9	2.9	3.8	4.8	5.7	6.7	7.6	8.6	9.5	
				18	n/r	1.2		0.8	0.8	0.9	1.1	1.6	2.1	2.6	3.2	3.7	4.2	4.8	5.3	
				14	n/r	0.6		0.4	0.5	0.5	0.6	0.9	1.1	1.4	1.7	2.0	2.3	2.6	2.9	

ASTM Embedment Material Classification		Density AASHTO T-99	E' kPa (psi)	DR	Depth of Cover (meters)													
					0.3	0.6		1	2	3	4	5	6	7	8	9	10	15
					% Deflection													
Manufactured Granular Angular	Class I	90%	20 700 (3,000)	25	0.7	0.5		0.3	0.3	0.4	0.5	0.7	0.8	0.9	1.1	1.2	1.4	2.0
				18	0.6	0.4		0.3	0.3	0.3	0.5	0.6	0.7	0.8	0.9	1.0	1.2	1.7
				14	0.5	0.3		0.2	0.2	0.3	0.4	0.4	0.5	0.6	0.7	0.8	0.9	1.3
Clean Sand & Gravel	Class II	90%	13 800 (2,000)	25	1.0	0.7		0.5	0.5	0.6	0.8	1.0	1.2	1.4	1.6	1.7	1.9	2.9
				18	0.8	0.5		0.4	0.4	0.5	0.6	0.8	0.9	1.1	1.2	1.4	1.6	2.3
				14	0.6	0.4		0.3	0.3	0.3	0.4	0.6	0.7	0.8	0.9	1.0	1.1	1.7
		80%	7 000 (1,000)	25	1.7	1.2		0.8	0.8	1.0	1.4	1.7	2.0	2.4	2.7	3.1	3.4	5.1
				18	1.2	0.8		0.6	0.6	0.7	0.9	1.2	1.4	1.7	1.9	2.1	2.4	3.6
				14	0.8	0.5		0.4	0.4	0.4	0.6	0.7	0.9	1.1	1.2	1.3	1.5	2.2
Sand & Gravel with Fines	Class III	90%	7 000 (1,000)	25	1.7	1.2		0.8	0.8	1.0	1.4	1.7	2.0	2.4	2.7	3.1	3.4	5.1
				18	1.2	0.8		0.6	0.6	0.7	0.9	1.2	1.4	1.7	1.9	2.1	2.4	3.6
				14	0.8	0.5		0.4	0.4	0.4	0.6	0.7	0.9	1.1	1.2	1.3	1.5	2.2
		85%	3 500 (500)	25	n/r	1.9		1.3	1.4	1.6	2.2	2.7	3.3	3.8	4.4	4.9	5.5	8.2
				18	n/r	1.1		0.8	0.8	1.0	1.3	1.6	1.9	2.3	2.6	2.9	3.2	4.8
				14	n/r	0.6		0.4	0.4	0.5	0.7	0.9	1.1	1.3	1.4	1.6	1.8	2.7
Silt & Clay	Class IV	85%	2 760 (400)	25	n/r	2.1		1.5	1.6	1.9	2.5	3.1	3.8	4.4	5.0	5.6	6.3	9.4
				18	n/r	1.2		0.8	0.9	1.0	1.4	1.7	2.1	2.4	2.8	3.1	3.5	5.2
				14	n/r	0.6		0.4	0.5	0.6	0.7	0.9	1.1	1.3	1.5	1.7	1.9	2.8



Percent % Deflection of IPEX CENTURION PIPE

ASTM Embedment Material Classification		Density AASHTO T-99	E' psi (kPa)	DR	Depth of Cover (feet)														
					1	2	4	6	8	10	15	20	25	30	35	40	45	50	
					% Deflection														
Manufactured Granular Angular	Class I	90%	3,000 (20 700)	51	n/r	0.5		0.3	0.4	0.4	0.5	0.7	0.9	1.1	1.4	1.6	1.8	2.0	2.3
				41	n/r	0.5		0.3	0.4	0.4	0.4	0.7	0.9	1.1	1.3	1.6	1.8	2.0	2.2
				32.5	0.7	0.5		0.3	0.3	0.4	0.4	0.7	0.9	1.1	1.3	1.5	1.7	2.0	2.2
				25	0.7	0.5		0.3	0.3	0.4	0.4	0.6	0.8	1.0	1.2	1.4	1.6	1.9	2.1
Clean Sand & Gravel	Class II	90%	2,000 (13 800)	51	n/r	0.7		0.5	0.5	0.6	0.7	1.0	1.3	1.7	2.0	2.3	2.7	3.0	3.4
				41	n/r	0.7		0.5	0.5	0.6	0.7	1.0	1.3	1.7	2.0	2.3	2.6	3.0	3.3
				32.5	1.0	0.7		0.5	0.5	0.5	0.6	1.0	1.3	1.6	1.9	2.2	2.6	2.9	3.2
				25	1.0	0.7		0.4	0.5	0.5	0.6	0.9	1.2	1.5	1.8	2.1	2.4	2.7	2.9
	Class II	80%	1,000 (7 000)	51	n/r	1.5		1.0	1.1	1.1	1.3	2.0	2.6	3.3	4.0	4.6	5.3	5.9	6.6
				41	n/r	1.4		1.0	1.0	1.1	1.3	1.9	2.6	3.2	3.8	4.5	5.1	5.8	6.4
				32.5	2.0	1.3		0.9	1.0	1.0	1.2	1.8	2.4	3.0	3.6	4.2	4.8	5.4	6.0
				25	1.7	1.1		0.8	0.8	0.9	1.0	1.6	2.1	2.6	3.1	3.6	4.2	4.7	5.2
Sand & Gravel with Fines	Class III	90%	1,000 (7 000)	51	n/r	1.5		1.0	1.1	1.1	1.3	2.0	2.6	3.3	4.0	4.6	5.3	5.9	6.6
				41	n/r	1.4		1.0	1.0	1.1	1.3	1.9	2.6	3.2	3.8	4.5	5.1	5.8	6.4
				32.5	2.0	1.3		0.9	1.0	1.0	1.2	1.8	2.4	3.0	3.6	4.2	4.8	5.4	6.0
				25	1.7	1.1		0.8	0.8	0.9	1.0	1.6	2.1	2.6	3.1	3.6	4.2	4.7	5.2
	Class III	85%	500 (3 500)	51	n/r	n/r		1.9	2.0	2.2	2.6	3.8	5.1	6.4	7.7	8.9	10.2	11.5	12.8
				41	n/r	n/r		1.8	1.9	2.1	2.4	3.6	4.8	6.0	7.2	8.4	9.6	10.8	12.0
				32.5	n/r	2.4		1.6	1.7	1.8	2.1	3.2	4.3	5.3	6.4	7.5	8.5	9.6	10.7
				25	n/r	1.9		1.3	1.3	1.4	1.7	2.5	3.3	4.2	5.0	5.9	6.7	7.5	8.4
Silt & Clay	Class IV	85%	400 (2 760)	51	n/r	n/r		2.4	2.5	2.7	3.1	4.7	6.3	7.9	9.4	11.0	12.6	14.1	15.7
				41	n/r	n/r		2.2	2.3	2.5	2.9	4.4	5.8	7.3	8.8	10.2	11.7	13.1	14.6
				32.5	n/r	2.8		1.9	2.0	2.2	2.5	3.8	5.1	6.3	7.6	8.9	10.1	11.4	12.7
				25	n/r	2.1		1.4	1.5	1.6	1.9	2.9	3.8	4.8	5.7	6.7	7.6	8.6	9.5

ASTM Embedment Material Classification		Density AASHTO T-99	E' kPa (psi)	DR	Depth of Cover (meters)													
					0.3	0.6	1	2	3	4	5	6	7	8	9	10	15	
					% Deflection													
Manufactured Granular Angular	Class I	90%	20 700 (3,000)	51	n/r	0.5		0.4	0.4	0.4	0.6	0.7	0.9	1.0	1.2	1.3	1.1	2.2
				41	n/r	0.5		0.3	0.4	0.4	0.6	0.7	0.9	1.0	1.2	1.3	1.5	2.2
				32.5	0.7	0.5		0.3	0.3	0.4	0.5	0.7	0.8	1.0	1.1	1.2	1.4	2.0
				25	0.7	0.5		0.3	0.3	0.4	0.5	0.7	0.8	0.9	1.1	1.2	1.4	2.0
Clean Sand & Gravel	Class II	90%	13 800 (2,000)	51	n/r	0.7		0.5	0.5	0.7	0.9	1.1	1.3	1.5	1.8	2.0	2.2	3.3
				41	n/r	0.7		0.5	0.5	0.6	0.9	1.1	1.3	1.5	1.7	1.9	2.2	3.2
				32.5	1.0	0.7		0.5	0.5	0.6	0.8	1.0	1.3	1.5	1.7	1.9	2.1	3.1
				25	1.0	0.7		0.5	0.5	0.6	0.8	1.0	1.2	1.4	1.6	1.7	1.9	2.9
	Class II	80%	7 000 (1,000)	51	n/r	1.5		1.0	1.1	1.3	1.7	2.2	2.6	3.0	3.5	3.9	4.3	6.5
				41	n/r	1.4		1.0	1.0	1.3	1.7	2.1	2.5	2.9	3.4	3.8	4.2	6.3
				32.5	2.0	1.3		0.9	1.0	1.2	1.6	2.0	2.4	2.8	3.2	3.5	3.9	5.9
				25	1.7	1.2		0.8	0.8	1.0	1.4	1.7	2.0	2.4	2.7	3.1	3.4	5.1
Sand & Gravel with Fines	Class III	90%	7 000 (1,000)	51	n/r	1.5		1.0	1.1	1.3	1.7	2.2	2.6	3.0	3.5	3.9	4.3	6.5
				41	n/r	1.4		1.0	1.0	1.3	1.7	2.1	2.5	2.9	3.4	3.8	4.2	6.3
				32.5	2.0	1.3		0.9	1.0	1.2	1.6	2.0	2.4	2.8	3.2	3.5	3.9	5.9
				25	1.7	1.2		0.8	0.8	1.0	1.4	1.7	2.0	2.4	2.7	3.1	3.4	5.1
	Class III	85%	3 500 (500)	51	n/r	n/r		2.0	2.1	2.5	3.3	4.2	5.0	5.9	6.7	7.5	8.4	12.6
				41	n/r	n/r		2.0	2.4	3.1	3.9	4.7	5.5	6.3	7.1	7.9	11.8	
				32.5	n/r	2.4		1.7	1.7	2.1	2.8	3.5	4.2	4.9	5.6	6.3	7.0	10.5
				25	n/r	1.9		1.3	1.4	1.6	2.2	2.7	3.3	3.8	4.4	4.9	5.5	8.2
Silt & Clay	Class IV	85%	2 760 (400)	51	n/r	n/r		2.4	2.6	3.1	4.1	5.2	6.2	7.2	8.3	9.3	10.3	15.5
				41	n/r	n/r		2.3	2.4	2.9	3.8	4.8	5.7	6.7	7.7	8.6	9.6	14.4
				32.5	n/r	2.8		2.0	2.0	2.5	3.3	4.1	5.0	5.8	6.7	7.5	8.3	12.4
				25	n/r	2.1		1.5	1.6	1.9	2.5	3.1	3.8	4.4	5.0	5.6	6.3	9.4



Percent % Deflection of CYCLE TOUGH PIPE

ASTM Embedment Material Classification		Density AASHTO T-99	E' psi (kPa)	SDR	Depth of Cover (feet)														
					1	2	4	6	8	10	15	20	25	30	35	40	45	50	
					% Deflection														
Manufactured Granular Angular	Class I	90%	3,000 (20 700)	41	n/r	0.5		0.3	0.4	0.4	0.4	0.7	0.9	1.1	1.3	1.6	1.8	2.0	2.2
				32.5	0.7	0.5		0.3	0.3	0.4	0.4	0.7	0.9	1.1	1.3	1.5	1.7	2.0	2.2
				25	0.7	0.5		0.3	0.3	0.4	0.4	0.6	0.8	1.0	1.2	1.5	1.7	1.9	2.1
				21	0.6	0.4		0.3	0.3	0.3	0.4	0.6	0.8	1.0	1.2	1.3	1.5	1.7	1.9
Clean Sand & Gravel	Class II	90%	2,000 (13 800)	41	n/r	0.7		0.5	0.5	0.6	0.7	1.0	1.3	1.7	2.0	2.3	2.6	3.0	3.3
				32.5	1.0	0.7		0.5	0.5	0.5	0.6	1.0	1.3	1.6	1.9	2.2	2.6	2.9	3.2
				25	1.0	0.7		0.5	0.5	0.5	0.6	0.9	1.2	1.5	1.8	2.1	2.4	2.7	3.0
				21	0.9	0.6		0.4	0.4	0.5	0.5	0.8	1.1	1.3	1.6	1.9	2.1	2.4	2.7
	Class II	80%	1,000 (7 000)	41	n/r	1.4		1.0	1.0	1.1	1.3	1.9	2.6	3.2	3.8	4.5	5.1	5.8	6.4
				32.5	2.0	1.3		0.9	1.0	1.0	1.2	1.8	2.4	3.0	3.6	4.2	4.8	5.4	6.0
				25	1.7	1.2		0.8	0.9	0.9	1.1	1.6	2.1	2.7	3.2	3.7	4.3	4.8	5.3
				21	1.4	1.0		0.7	0.7	0.8	0.9	1.3	1.8	2.2	2.7	3.1	3.5	4.0	4.4
Sand & Gravel with Fines	Class III	90%	1,000 (7 000)	41	n/r	1.4		1.0	1.0	1.1	1.3	1.9	2.6	3.2	3.8	4.5	5.1	5.8	6.4
				32.5	2.0	1.3		0.9	1.0	1.0	1.2	1.8	2.4	3.0	3.6	4.2	4.8	5.4	6.0
				25	1.7	1.2		0.8	0.9	0.9	1.1	1.6	2.1	2.7	3.2	3.7	4.3	4.8	5.3
				21	1.4	1.0		0.7	0.7	0.8	0.9	1.3	1.8	2.2	2.7	3.1	3.5	4.0	4.4
	Class III	85%	500 (3 500)	41	n/r	n/r		1.8	1.9	2.1	2.4	3.6	4.8	6.0	7.2	8.4	9.6	10.8	12.0
				32.5	n/r	2.4		1.6	1.7	1.8	2.1	3.2	4.3	5.3	6.4	7.5	8.5	9.6	10.7
				25	n/r	1.9		1.3	1.4	1.5	1.8	2.6	3.5	4.4	5.3	6.1	7.0	7.9	8.8
				21	n/r	1.4		1.0	1.0	1.1	1.3	2.0	2.6	3.3	3.9	4.6	5.2	5.9	6.5
Class IV	85%	400 (2 760)	41	n/r	n/r		2.2	2.3	2.5	2.9	4.4	5.8	7.3	8.8	10.2	11.7	13.1	14.6	
			32.5	n/r	2.8		1.9	2.0	2.2	2.5	3.8	5.1	6.3	7.6	8.9	10.1	11.4	12.7	
			25	n/r	2.2		1.5	1.6	1.7	2.0	3.0	4.0	5.0	6.0	7.0	8.0	9.06	10.0	
			21	n/r	1.6		1.1	1.2	1.2	1.4	2.2	2.9	3.6	4.3	5.1	5.8	6.5	7.2	

ASTM Embedment Material Classification		Density AASHTO T-99	E' kPa (psi)	SDR	Depth of Cover (meters)														
					0.3	0.6	1	2	3	4	5	6	7	8	9	10	15		
					% Deflection														
Manufactured Granular Angular	Class I	90%	20 700 (3,000)	41	n/r	0.5		0.3	0.4	0.4	0.6	0.7	0.9	1.0	1.2	1.3	1.5	2.2	
				32.5	0.7	0.5		0.3	0.4	0.4	0.6	0.7	0.9	1.0	1.1	1.3	1.4	2.1	
				25	0.7	0.5		0.3	0.3	0.4	0.5	0.7	0.8	1.0	1.1	1.2	1.4	2.0	
				21	0.6	0.4		0.3	0.3	0.4	0.5	0.6	0.8	0.9	1.0	1.1	1.3	1.9	
Clean Sand & Gravel	Class II	90%	13 800 (2,000)	41	n/r	0.7		0.5	0.5	0.6	0.9	1.1	1.3	1.5	1.7	1.9	2.2	3.2	
				32.5	1.0	0.7		0.5	0.5	0.6	0.8	1.0	1.3	1.5	1.7	1.9	2.1	3.1	
				25	1.0	0.7		0.5	0.5	0.6	0.8	1.0	1.2	1.4	1.6	1.8	2.0	2.9	
				21	0.9	0.6		0.4	0.4	0.5	0.7	0.9	1.1	1.2	1.4	1.6	1.8	2.6	
	Class II	80%	7 000 (1,000)	41	n/r	1.4		1.0	1.0	1.3	1.7	2.1	2.5	2.9	3.4	3.8	4.2	6.3	
				32.5	2.0	1.3		0.9	1.0	1.2	1.6	2.0	2.4	2.8	3.2	3.5	3.9	5.9	
				25	1.7	1.2		0.8	0.9	1.0	1.4	1.8	2.1	2.5	2.8	3.1	3.5	5.3	
				21	1.4	1.0		0.7	0.7	0.9	1.2	1.4	1.7	2.0	2.3	2.6	2.9	4.3	
Sand & Gravel with Fines	Class III	90%	7 000 (1,000)	41	n/r	1.4		1.0	1.0	1.3	1.7	2.1	2.5	2.9	3.4	3.8	4.2	6.3	
				32.5	2.0	1.3		0.9	1.0	1.2	1.6	2.0	2.4	2.8	3.2	3.5	3.9	5.9	
				25	1.7	1.2		0.8	0.9	1.0	1.4	1.8	2.1	2.5	2.8	3.1	3.5	5.3	
				21	1.4	1.0		0.7	0.7	0.9	1.2	1.4	1.7	2.0	2.3	2.6	2.9	4.3	
	Class III	85%	3 500 (500)	41	n/r	n/r		1.9	2.0	2.4	3.1	3.9	4.7	5.5	6.3	7.1	7.9	11.8	
				32.5	n/r	2.4		1.7	1.7	2.1	2.8	3.5	4.2	4.9	5.6	6.3	7.0	10.5	
				25	n/r	1.9		1.4	1.4	1.7	2.3	2.9	3.5	4.0	4.6	5.2	5.7	8.6	
				21	n/r	1.4		1.0	1.1	1.3	1.7	2.1	2.6	3.0	3.4	3.9	4.3	6.4	
Class IV	85%	2 760 (400)	41	n/r	n/r		2.3	2.4	2.9	3.8	4.8	5.7	6.7	7.7	8.6	9.6	14.4		
			32.5	n/r	2.8		2.0	2.1	2.5	3.3	4.1	5.0	5.8	6.7	7.5	8.3	12.4		
			25	n/r	2.2		1.6	1.6	2.0	2.6	3.3	4.0	4.6	5.3	5.9	6.6	9.9		
			21	n/r	1.6		1.1	1.2	1.4	1.9	2.4	2.8	3.3	3.8	4.3	4.7	7.1		



**Percent % Deflection of IPEX BIONAX and
BIONAX SR CIOD PIPE**

ASTM Embedment Material Classification	Density AASHTO T-99	E' psi (kPa)	PC/PR (psi)	Depth of Cover (feet)															
				1	2	4			6	8	10	15	20	25	30	35	40	45	50
				% Deflection															
Class I	90%	3,000	235	0.7	0.4	0.3			0.3	0.4	0.4	0.6	0.9	1.1	1.3	1.5	1.7	1.9	2.1
Class II	90%	2,000	235	1.0	0.5	0.5			0.5	0.5	0.6	0.9	1.2	1.6	1.9	2.2	2.5	2.8	3.1
	80%	1000	235	1.8	1.0	0.8			0.9	1.0	1.1	1.7	2.3	2.9	3.4	4.0	4.6	nr	nr
Class III	90%	1,000	235	1.8	1.0	0.8			0.9	1.0	1.1	1.7	2.3	2.9	3.4	4.0	4.6	nr	nr
	85%	500	235	3.1	1.7	1.4			1.5	1.7	2.0	2.9	3.9	4.9	nr	nr	nr	nr	nr
Class IV	85%	400	235	3.7	2.0	1.7			1.8	2.0	2.3	3.4	4.6	nr	nr	nr	nr	nr	nr

ASTM Embedment Material Classification	Density AASHTO T-99	E' kPa (psi)	PC/PR (psi)	Depth of Cover (meters)															
				0.3	0.6	1			2	3	4	5	6	7	8	9	10	12	15
				% Deflection															
Class I	90%	20 700	1620	0.7	0.4	0.3			0.4	0.5	0.6	0.7	0.8	1.0	1.1	1.3	1.4	1.7	2.1
Class II	90%	13 800	1620	1.0	0.5	0.4			0.5	0.7	0.8	1.0	1.2	1.4	1.6	1.8	2.0	2.4	3.1
	80%	7 000	1620	1.8	1.0	0.8			0.9	1.2	1.5	1.9	2.2	2.6	3.0	3.4	3.7	4.5	n/r
Class III	90%	7 000	1620	1.8	1.0	0.8			0.9	1.2	1.5	1.9	2.2	2.6	3.0	3.4	3.7	4.5	n/r
	85%	3 500	1620	3.1	1.7	1.3			1.6	2.1	2.6	3.2	3.9	4.5	n/r	n/r	n/r	n/r	n/r
Class IV	85%	2 800	1620	3.7	2.0	1.5			1.9	2.4	3.0	3.7	4.5	n/r	n/r	n/r	n/r	n/r	n/r



TESTING

Checklist

Merely filling the pipeline with city pressure will impose some stresses on the pipe and its appurtenances. Here is a checklist to run through before filling the line.

1. Has enough time been allowed to permit concrete thrust blocks to cure?
2. Has enough backfill material been placed over the pipe to prevent its movement during test? A minimum of 1-1/2 pipe diameters is recommended.
3. Has provision been made to permit the escape of air from the upper reaches of the pipeline as it is being filled?
4. If the line is not completed, has an adequate means of blocking the test cap or plug been made? Even at low test pressures the thrust forces developed in large diameter pipes can be formidable.

Block thrust forces before testing.



Filling the Line

In most cases the designer of the pipeline will make provision for the release of air at the high points. Air release valves are commonly used for this purpose. If this is not the case, a corporation stop can be installed at the highest elevation of the system to help vent air during filling. The filling water should be introduced to the pipeline at the lowest point possible, and at a preferred filling rate of 1 fps (0.3 m/s) or less. An excessive filling rate can introduce air which can cause severe water hammer effects.

Nominal Size		Max Filling Rate	
In	mm	gpm	L/s
4	100	40	2.5
6	150	87	5.5
8	200	157	9.9
10	250	245	15
12	300	353	22
14	350	480	30
16	400	627	39
18	450	793	50
20	500	979	61
24	600	1410	89
30	750	2203	139
36	900	3173	200
42	1050	4318	272
48	1200	5640	355
54	1350	7342	465
60	1500	8405	532

How Much Water is Needed to Fill 100 ft (30 m) of Pipe?

A simple formula can be used to calculate the volume of water needed to fill 100 feet (30m) of pipe. First, find the outside diameter of the pipe (OD) in inches. Knowing the Dimension Ratio (DR) calculate:

$$\text{U.S. gal. of water needed} = 4.08 \left[\text{OD} - 2 \left(\frac{\text{OD}}{\text{DR}} \right) \right]^2 \text{ U.S.gal./100 ft.}$$

Note: 1 US gal. = 3.79 liters
1 cubic meter= 1,000 liters

Pressure and Leakage Tests

⚠ WARNING

- NEVER use compressed air or gas in IPEX municipal pipe and fittings.
- NEVER test IPEX municipal pipe and fittings with compressed air or gas, or air-over-water boosters.



Use of compressed air or gas in IPEX municipal pipe and fittings can result in explosive failures and cause severe injury or death.

Although they have different purposes it is now common practice to combine leakage tests and pressure tests into one single test to ensure that IPEX pipe and fittings provide a leak tight system.

A pressure test will determine the soundness of the pipeline and its appurtenances. A successful pressure test will reassure the engineer and the owner that the line is capable of sustaining both the working pressure and those additional pressures that may be introduced from time to time as a result of normal operation.

The pressure used in the pressure test should not be higher than needed to accomplish that objective. Typically, the pressure test will be carried out at the maximum working pressure plus 50 psi (345 kPa). Remember that all parts of the line, including thrust blocks will be subjected to the test pressure.



IPEX PVC and PVC Pressure Pipe may be pressure tested in an underground installation to levels indicated in the table below. Test pressure is 25% above the pressure class/rating of the pipe.

PVC Pipe Maximum Recommended Test Pressures

Dimension Ratio DR	Test Pressure	
	psi	kPa
14	380	2630
18	295	2025
21	250	1725
25	205	1420
26	200	1380
32.5	155	1080
41	125	860
51	100	690

Bionax PVC Pipe Maximum Recommended Test Pressures

Pressure Class/Rating PC/PR	Test Pressure	
	psi	kPa
PC/PR 235	295	2025

NOTE:

- Verify test pressure does not exceed appurtenance or restraint requirements.
- It is possible to exceed above test pressures under specific conditions. Contact IPEX for details.

For PVC pipe with direct-tapped service connections, the above maximum test values should be reduced to the pipe pressure rating (i.e. multiply by 0.8).

The installer is cautioned that for most installations, the above values may exceed the test rating of other pipeline appurtenances such as valves, hydrants, or fittings. Excessively high pressure testing may also affect the size of thrust blocks or quantity of mechanical restrainers, and thus possibly increase the overall project costs.

The presence of air in the pipeline during the pressure test may give the appearance of a failure. If the measured amount of makeup water to achieve pressure on successive tests is declining then the presence of air is positively indicated. The line must be vented before testing continues.

In the absence of other instructions, a two-hour combined pressure and leakage test is recommended. During this 2-hour test, a small drop in pressure may occur. At the end of 2-hours, the line is refilled with makeup water until initial test pressure is achieved. The volume of makeup water is measured as it is being added and can be calculated using either of the formulas below:

$$(U.S. Gallons) L = \frac{N D \sqrt{P}}{7400} \quad \text{or} \quad (Liters) L = \frac{N D \sqrt{P}}{128650}$$

where, L = allowable makeup water, US Gal. (or liters)

N = number of joint lengths

D = nominal pipe diameter, inches (or mm)

P = test pressure, psi (or kPa)

Or, the maximum allowable makeup for a particular size, test pressure and length of PVC pipe can be found using either of the tables presented:

Makeup Water Allowance U.S. Gallons per 1000 ft (50 joints) per Hour						
Pipe Size inches	Test Pressure (psi)					
	50	100	150	200	250	300
4	.19	.27	.33	.38	.43	.47
6	.29	.41	.50	.57	.64	.70
8	.38	.54	.66	.76	.85	.94
10	.48	.68	.83	.96	1.07	1.18
12	.57	.81	.99	1.95	1.28	1.41
14	.67	.95	1.16	1.34	1.50	1.65
16	.76	1.08	1.32	1.53	1.71	1.88
18	.86	1.22	1.49	1.72	1.92	2.12
20	.96	1.35	1.66	1.91	2.14	2.35
24	1.15	1.62	1.99	2.29	2.56	2.82
30	1.43	2.03	2.48	2.87	3.21	3.53
36	1.72	2.43	2.98	3.44	3.85	4.24
42	2.01	2.84	3.48	4.01	4.49	4.94
48	2.30	3.25	3.98	4.58	5.13	5.65
54	2.58	3.65	4.47	5.16	5.77	6.32
60	2.87	4.05	4.97	5.73	6.41	7.02



Makeup Water Allowance Liters per 305 meters (50 joints) per Hour						
Pipe Size	Test Pressure (kPa)					
	350	700	1050	1400	1750	2100
mm						
100	0.73	1.03	1.26	1.46	1.63	1.78
150	1.09	1.54	1.89	2.18	2.44	2.67
200	1.45	1.54	2.52	2.91	3.25	3.56
250	1.82	2.57	3.15	3.64	4.07	4.45
300	2.18	3.09	3.78	4.37	4.88	5.35
350	2.54	3.60	4.41	5.09	5.69	6.23
400	2.91	4.12	5.04	5.82	6.51	7.13
450	3.27	4.63	5.67	6.55	7.32	8.01
500	3.64	5.14	6.30	7.28	8.14	8.90
600	4.36	6.18	7.56	8.74	9.76	10.70
750	5.46	7.71	9.45	10.92	12.21	13.35
900	6.54	9.26	11.34	13.10	14.64	16.02
1050	7.64	10.80	12.23	15.29	17.09	18.70
1200	8.72	12.36	15.12	17.48	19.52	21.40
1350	9.82	13.88	17.00	19.63	21.95	24.04
1500	10.91	15.42	18.89	21.81	24.39	26.72

Often with gasketed PVC pipe, no makeup water will be required, i.e. the pressure will not drop at all over the 2 hours. However, if some water is required, it does not necessarily imply that the pipe is leaking. A pressure drop may have occurred for one or all of the following reasons:

- air entrapment in line
- radial expansion of the pipe
- initial slippage of mechanical restrainers

If the system requires makeup water in excess of the allowable values in the table, a leak in the system is likely. The installer must then locate, excavate and repair any leaks before re-testing the line.

It is good practice to first check all line appurtenances for leakage such as tees, elbows, line valves, relief valves or service connections. These types of connections have historically shown a higher likelihood of an improper seal should a system leak be present.

REPAIRS

Should it be necessary to replace a section of pipe, IPEX provides a repair coupling to simplify and speed up the repair operation. The replacement section can consist of a length of pipe with two spigot ends and two double-bell repair couplings or a length of pipe with an integral bell and one spigot end and one double-bell repair coupling.

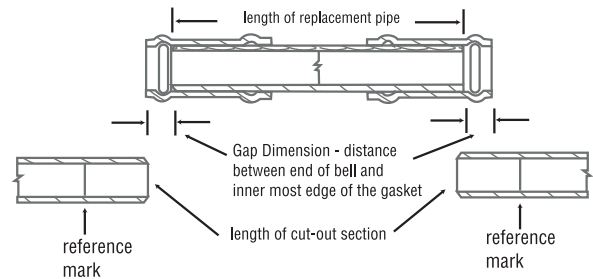

When cutting out the section be sure that all the damage is included (i.e.) no hairline fractures are left in the line and that there is enough room to carry out the repairs.

1. Determine the length of the replacement section as shown in the figure above. Cut the pipe to the proper length.
2. Bevel the ends of the pipeline and the repair section. Locate the reference marks on all ends.
3. Mount the couplings as shown above (or on the pipeline ends instead of the replacement section).
4. Insert the replacement section into the pipeline and slide the couplings into position as shown below. The couplings should be centered over the gap and midway between the reference marks.

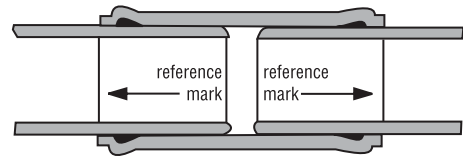

When using a section with an integral bell, more of the pipeline may have to be exposed to enable the pipeline to be deflected to allow the proper alignment of the replacement joint. When determining the length of the replacement section, take care to allow for the gap dimension on one end only. Complete the integral bell joint first then slide the double-bell coupling into place.



INSTALLING PVC & PVCO PIPE THROUGH CASINGS

Precautions

When the direction of laying intercepts a heavily-travelled, protected or landscaped area it may be necessary to install the pipe through a protective casing. In this case the casing will support the earth load and the live load that would otherwise be transmitted to the PVC pipe. There are four major precautions to observe in the design of the casings, and while pulling the pipe through the casing. These are:

1. Select the appropriate casing size.
2. Install spacers and skids on the PVC pipe.
3. Minimize the friction force during the pull, and avoid over-belling.
4. Install a water-permeable seal at the casing ends.

Casing Size

The casing size should be large enough to readily accommodate the maximum outside diameter at the pipe bells and the projections of the supporting skids, but not so large as to permit excessive "whipping" or "snaking" of the PVC pipe when it is pressurized after installation in the casing. Recommendations for the appropriate casing size are:

Recommended Minimum Casing Sizes			
Nominal Pipe Size		Minimum Casing Sizes (Inside Diameter)	
in	mm	in	mm
4	100	8	200
6	150	10	250
8	200	14	350
10	250	16	400
12	300	18	450
14	350	24	600
16	400	28	710
18	450	30	760
20	500	32	810
24	600	36	910
30	750	44	1120
36	900	48	1220
42	1050	54	1350
48	1200	60	1500
54	1350		
60	1500		

For maximum bell dimensions (D_{max}), see pages 20-22.

Skids

The pipe should not rest on the bells after installation in the casing. Runners, or skids, should be attached to the barrel of the pipe with steel straps for a sufficient distance along the barrel to prevent any portion of the pipe contacting the casing. Pipe sizes 12" (300mm) and under should have four skids arranged at 90° intervals around the pipe. Pipes over 12" (300mm) may need six skids at 60° around the pipe at intervals adequate to ensure that no part of the barrel or bell is in contact with the casing. To help prevent over-belling as the pipeline is pulled through the casing, place one set of runners with their ends even with the assembly line on the spigot end of the pipe (at A).

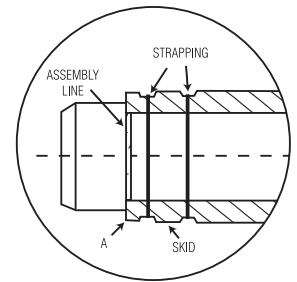

The wood used to make the skids should not be creosoted because this material will damage the pipe.

Mechanical Casing Spacers

Mechanical pipe spacers are available to provide protection between the carrier pipe and the casing. These spacers are manufactured from polyethylene, stainless steel or carbon steel and come complete with runners to provide clearance for the bell - spigot assemblies. The casing spacer manufacturer should be contacted for direct information on the location and number of casing spacers required.

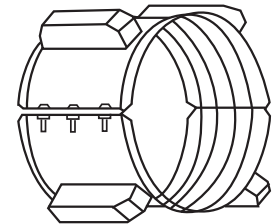

Casing Spacer Installation

4" (100mm) and 6" (150mm) pipes being installed in short casings can be easily pushed or jacked through. The pulling cable passes from the winch at the exit end of the casing through the casing and through the first length of pipe. At the end of the pulling cable a cross piece (preferably a 2 x 4 inch wooden piece) is placed across the bell of the pipe. The pull should be steady and slow, avoiding jerking movements. Place a protective wrap around the spigot end of the first length of pipe to fend off possible abrasion against the casing. The assembly is made in the usual way, taking care to complete the assembly to precisely the assembly line on the spigot. The pulling cable is threaded through the next length and the pull continues until the line is completed.

Sealing the Casing

After the pipeline has been tested and accepted, the space between the pipe and the casing may be filled with sand, and sealed with a permeable grout or mechanical seal at the entry and exit points. The material selected should be placed so that backfill cannot enter the casing, while water is permitted to escape. Should the contractor be obliged to use a grouting material between the pipe wall and casing, maximum recommended grouting pressures should not be exceeded.

PVC Pipe Maximum Recommended Grouting Pressures

DR	Maximum Grouting Pressure (psi)*
51	not recommended
41	not recommended
32.5	15
26	30
25	34
21	58
18	95
14	210

* These maximum pressures are based on the temperature in the wall of the pipe not exceeding 73°F (23°C). Maximum grouting pressures must be reduced with increased wall temperatures.

Bionax PVCO Pipe Maximum Recommended Grouting Pressures

Pressure Class/Rating PC/PR	Maximum Grouting Pressure psi
Rating 160	not recommended
Class/Rating 235	21

Maximum grouting pressure based on 2:1 safety factor



LUBRICANT USAGE JOINTS PER CONTAINER

Pipe Size		Average Number of Joints per Container					
		9 oz	Pint	Quart	Gallon	2½ Gallon	5 Gallon
in	mm	250 g	516 g	1 kg	4 kg	11 kg	23 kg
1-1/2	40	42	85	160	640	1840	3680
2	50	35	70	140	560	1610	3220
2-1/2	65	30	60	120	480	1380	2760
3	75	25	50	100	400	1150	2300
4	100	17	34	70	280	805	1610
5	125	14	28	56	225	645	1290
6	150	10	20	40	160	460	920
8	200	7	14	28	110	320	640
10	250	5	10	20	80	230	460
12	300	3	7	14	55	160	320
14	350	2	5	10	40	115	230
15	375	2	4	8	32	87	175
16	400	2	3	6	24	70	140
18	450	1	2	4	16	45	90
20	500	1	2	3	12	35	70
21	525	1	2	3	12	35	70
24	600	1	1	2	8	22	45
27	675		1	2	6	17	35
30	750			1	4	12	25
36	900				3	7	15
42	1050				2	5	10
48	1200				1	3	7
54	1350				1	2	5
60	1500					1	3

NOTES

How to use the chart:

$$\frac{\text{\# of feet of pipe per diameter}}{\text{lay length of pipe (ft)}} = \text{\# of joints}$$

or

$$\frac{\text{\# of meters of pipe per diameter}}{\text{lay length of pipe (m)}} = \text{\# of joints}$$

$$\frac{\text{\# of joints}}{\text{joints per containers}} = \text{\# of containers}$$



SALES AND CUSTOMER SERVICE

Customers call IPEX Inc.

Toll free: (866) 473-9462

ipexna.com

About the IPEX Group of Companies

As leading suppliers of thermoplastic piping systems, the IPEX Group of Companies provides our customers with some of the world's largest and most comprehensive product lines. IPEX products are backed by more than 50 years of experience. With state-of-the-art manufacturing facilities and distribution centers across North America, we have earned a reputation for product innovation, quality, end-user focus and performance.

Markets served by IPEX group products are:

- Electrical systems
- Telecommunications and utility piping systems
- PVC, CPVC, PP, PVDF, PE, ABS, and PEX pipe and fittings
- Industrial process piping systems
- Municipal pressure and gravity piping systems
- Plumbing and mechanical piping systems
- Electrofusion systems for gas and water
- Industrial, plumbing and electrical cements
- Irrigation systems

Products are manufactured by IPEX Inc.

BIONAX®, BIONAX® SR™, Cycle Tough®, IPEX Centurion® and TerraBrute® are trademarks of IPEX Branding Inc.

ipexna.com

This literature is published in good faith and is believed to be reliable. However, it does not represent and/or warrant in any manner the information and suggestions contained in this brochure. Data presented is the result of laboratory tests and field experience.

A policy of ongoing product improvement is maintained. This may result in modifications of features and/or specifications without notice