

NONMETALLIC LIGHT FIXTURES



Sceptalight™

ELECTRICAL SYSTEMS

- LED Light Fixture
- Incandescent Light Fixture
- Compact Fluorescent Light Fixture



IPEX

Committed to Excellence

www.ipexna.com

SCEPTALIGHT™: THE LIGHT THAT LASTS.

Whether you're looking for economical outdoor lighting solutions, corrosion-resistant fixtures for punishing industrial environments or energy-saving LED, Sceptalight fixtures from IPEX prove themselves to be all-round performers in a variety of indoor and outdoor applications. Sceptalight fixtures are made from a glass-reinforced thermoplastic polyester resin, which enable them to stand up better to corrosive elements than metal. This thermoplastic design marries an unrivaled balance of strength, stiffness and toughness with all the benefits users appreciate of Scepter rigid PVC conduit and fittings – long life, easy servicing and high impact-resistance.

Sceptalight's thermoplastic construction offers outstanding corrosion and chemical resistance. Silicone gaskets in Sceptalight fixtures – mounted at the base of the globe and within the ceiling box – provide a water- and vapour-tight seal which protects the electrical connections inside.

Wherever you need a lighting fixture that can withstand exposure to chemicals, fluids or harsh physical conditions, you'll find a home for Sceptalight.

TYPICAL APPLICATIONS



 Agriculture



 Industrial/Commercial



 Mine Tunnel



 Greenhouse



 Waste Water



 Marine



WET LOCATIONS

C22.2 No. 250

CSA Listed to UL 1598

Minimum 60°C supply conductors

CSA certified for wet locations, Sceptalight fixtures are built to withstand any environment where liquids drip, splash or flow against electrical equipment. And our polycarbonate globes are an excellent alternative to glass in punishing environments where high impact resistance is important. Sceptalight fixtures can operate in extreme temperatures and are resistant to damaging ultraviolet rays. For years, our fixtures have been proven performers on docks, wharfs, decks, walkways, shipyards and a variety of other applications where exposed to the elements.

LIGHT OPTIONS	
LED	✓
Incandescent	✓
Compact Fluorescent	✓



HAZARDOUS LOCATIONS

CSA Listed to UL 844

CLASS I, DIV 2 Groups A, B, C & D CLASS II,

DIV 2 Groups F & G

Minimum 90°C supply conductors

Sceptalight offers fixtures that are CSA certified for hazardous locations, making them the ideal choice for specific harsh industrial environments involving flammable or explosive gases, vapours or dusts. In addition to their sturdy construction, all our fixtures rated for hazardous locations include a heat-treated globe designed to endure drastic temperature changes such as direct spray of cool water on a hot fixture. Sceptalight fixtures are equipped with brass screws and inserts to ensure performance in punishing industrial conditions.

LIGHT OPTIONS	
LED	
Incandescent	✓
Compact Fluorescent	✓

SUGGESTED SPECIFICATION

Light fixtures shall be nonmetallic and constructed of 30% glass filled polyester material exhibiting a maximum linear expansion of 1.4x10⁻⁵ in./in./°F. Fixtures shall be assembled with high temperature silicone gaskets, brass inserts and screws.

Incandescent light fixtures shall be rated for use with a Maximum 150 Watt incandescent lamp. Compact fluorescent light fixtures shall be of the wattage specified and be supplied complete with lamp and ballast (high power factor, low harmonic electronic for 18 & 26 Watt fixtures and magnetic for 7, 9 & 13 Watt fixtures).

Light fixtures shall be third-party certified to CSA C22.2 No. 9 and C22.2 No. 250 for indoor/outdoor wet location use and where the specified installation requires; Class I Div 2 and Class II Div 2 hazardous location use.

LED light fixtures shall be third-party certified to CSA 22.2 250.0. LED light fixtures will also be NEMA 4X and IP66 rated for wash-down and corrosive environments. LED Retrofit Light Engines shall be certified to CSA T.I.L. B-79A and conform to UL 1598C.

Approved products: Sceptalight LVPE/LVPF/LVPL/LBPE/LPMF/LPPL series light fixtures manufactured by IPEX Electrical Inc.





SCEPTALIGHT™ LED

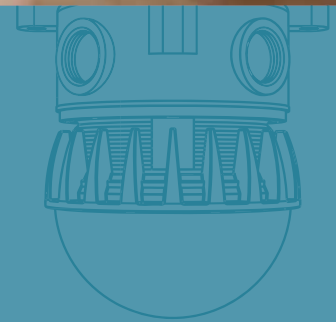

Sceptalight LEDs provide exceptional light quality compared to conventional light sources. Due to their wider spectral distribution, objects lit by Sceptalight LEDs are much more visible and vivid in colour.

Introducing three new Sceptalight LED products: the LED Retrofit Light Engine, the Heavy-Duty LED Light Fixture and the Utility LED Light Fixture. Sceptalight LEDs offer significant energy savings, up to 85% compared to incandescent, and up to 34% compared to fluorescents. Moreover, Sceptalight LEDs can last beyond 50,000 hours without a single need for maintenance.

Constructed of very strong and durable materials, the polycarbonate globe is impact resistant and is resistant to UV light degradation. The specially designed aluminum heat sink dissipates the heat generated by the LEDs to the exterior environment ensuring long-life and optimal performance in both hot and cold environments. Sceptalight LEDs have been tested and certified for use in indoor, outdoor, wet location, wash down and corrosive environments. They are certified to the latest LED light fixture standards and NEMA 4X approved.



RETROFIT OPTION

Sceptalight LEDs can easily retrofit onto existing installations for increased energy savings.

ENERGY EFFICIENT

1,000 lumens of light output is produced with only 15 Watts of electricity.

DIMMABLE

Lights are dimmable down to 5% for maximum control of the lighting environment.

NEMA 4X AND IP66 RATED

Approved for wet locations, wash down and corrosive environments.

CORROSION RESISTANT

Heat sink is coated with a durable e-coat layer that prevents corrosion.

HEAT DISSIPATION

Specially designed heat sink ensures long life and optimum performance for over 50,000 hours.

POLYCARBONATE GLOBE

Impact and weather resistant for tough environments.

TECHNICAL SPECIFICATIONS

LUMEN OUTPUT	1000 LM	POWER FACTOR	0.98
INPUT VOLTAGE	120 VAC	TOTAL HARMONIC DISTORTION	10.5%
FREQUENCY	60 HZ	OPERATING TEMPERATURE	-40°C TO 40°C
NOMINAL POWER	15 W	DIMMABILITY RANGE	DOWN TO 5%
COLOUR TEMPERATURE	5000 K	RATED LIFE	> 50,000 HOURS
CRI	> 80	WARRANTY*	5 YEARS

STANDARDS

LIGHT FIXTURE (LVPF/LVPE-LED)	CSA C22.2 250.0	UL 1598
LIGHT ENGINE (LLED-15)	CSA T.I.L. B-79A	UL 1598C

*LIMITED WARRANTY & LIMITATION OF LIABILITY: Consult IPEX Sceptalight™ LED Retrofit Light Engine Specific Terms and Conditions of Sale and Limited Warranty and Limitation of Liability for further details, available at www.ipexna.com

PHOTOMETRIC DATA

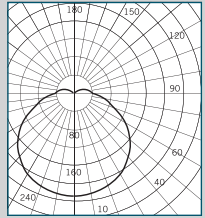

15W 120V
Frosted LED



SCEPTALIGHT™

COMPACT FLUORESCENT

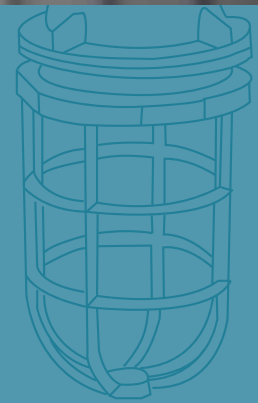

Sceptalight Compact Fluorescent fixtures provide lower energy and maintenance costs without sacrificing light levels. The UV resistant material makes them suitable for both indoor and outdoor use.

Sceptalight Compact Fluorescent fixtures combine the outstanding corrosion and chemical resistance of their thermoplastic design with the energy-saving advantages of compact fluorescents. Working four to five times more efficiently per watt than incandescents, Sceptalight compact fluorescents provide 10-20 times the lamp life. Without sacrificing light levels, they use 75% less energy than incandescents for a lower total energy and maintenance cost. They are available in twin tube and quad tube configurations and include ballast.

Twin Tubes

- Available in 7, 9 & 13 Watt
- Standard Magnetic Ballast

Quad Tubes

- Available in 18 & 26 Watt
- Electronic Ballast provides "Instant Start" at temps as low as -25°C
- Offers 10,000 hours of lamp life



STABLE CONSTRUCTION

Reinforced support feet offer secure mounting.

ADAPTABLE

Threaded conduit hubs permit connection to nonmetallic and metallic raceways.

WATERTIGHT SEAL

Temperature and weather-resistant gaskets protect fixture from moisture penetration.

LONG LIFE

Sceptalight nonmetallic fixtures provide long life and easy servicing—unlike metal fixtures and guards that can corrode and seize together.

INDOOR/OUTDOOR USE

UV-resistant material makes Sceptalight fixtures suitable for both indoor and outdoor use.

CORROSION RESISTANT

Thermoplastic construction resists attack from acids, alcohols, alkalis, organic solvents, detergents/cleaners, greases and oils as well as many other types of chemicals. Withstands exposure to direct sunlight, heat, and extreme weather.

DURABLE, IMPACT RESISTANCE

High-impact nonmetallic guard resists physical impact, chemical attack and heat-induced deformation.

PHOTOMETRIC DATA

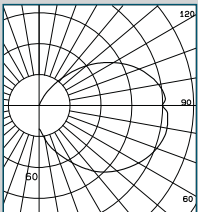

26W Quad
Compact
Fluorescent

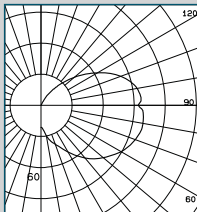

18W Quad
Compact
Fluorescent

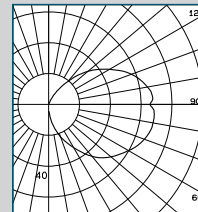

13W Twin-Tube
Compact
Fluorescent



SCEPTALIGHT™

INCANDESCENT

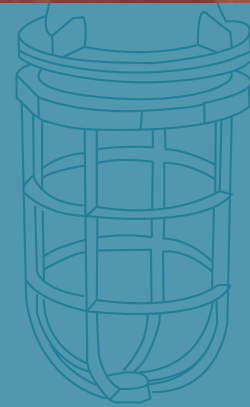

Sceptalight Incandescent fixtures are your cost effective solution for a variety of indoor and outdoor applications while still providing superior corrosion and chemical resistance.

Sceptalight incandescent fixtures make the most practical choice to meet the daily needs of commercial, industrial, marine and agricultural applications. Our incandescents will take up to a 150 watt incandescent bulb and are ideal for short burn times as well as flashing and dimming applications.

For light to medium duty applications that do not require the same level of ruggedness, Sceptalight has a low-cost ceiling-mounted Utility Light Fixture available in standard, clear polycarbonate and coloured heat-resistant globes.



INSTALLATION FLEXIBILITY

Fixtures can be mounted in ceiling, wall or pendant methods to accommodate installation requirements.

INDOOR/OUTDOOR USE

Temperature and weather-resistant gaskets protect fixture from moisture penetration.

COST EFFECTIVE SOLUTION

Inexpensive to install, the fixture takes up to a 150 watt incandescent bulb.

ADAPTABLE LIGHTING ENVIRONMENTS

Ideal for short burn times, flashing & dimming applications.

COLOURED GLOBES AVAILABLE

Available in a range of coloured heat-resistant globes to transform the light into an indicator or warning light.

CORROSION RESISTANT

Thermoplastic construction withstands exposure to direct sunlight, heat & extreme weather.

PHOTOMETRIC DATA

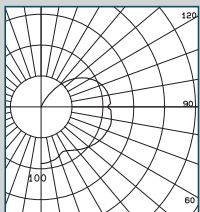

100W 120V
Coated A19
Incandescent

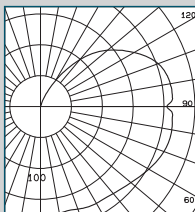

150W 120V
Coated A21
Incandescent

MOUNTING OPTIONS

Sceptalight LED can be retrofit with Ceiling Mounts only.

CEILING MOUNT

Box with four 3/4" threaded hubs and integral mounting feet.

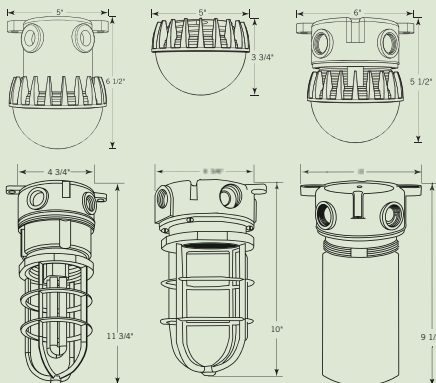

PENDANT MOUNT

Pendant cap with 3/4" threaded hub and a locking set screw.

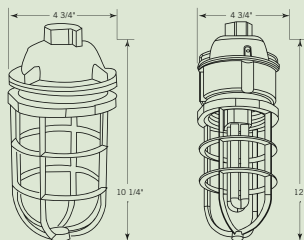

WALL MOUNT

Box with four 3/4" threaded hubs, 90° wall bracket and integral mounting feet.

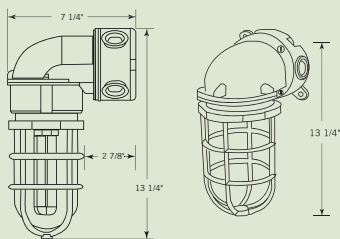

CEILING MOUNT UTILITY FIXTURES

Box with four 3/4" threaded hubs and integral mounting feet.

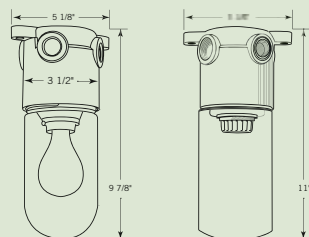

PRODUCT CATALOGUE

WET LOCATIONS

Ceiling Mount with Frosted Polycarbonate Globe

Description	Part Number	Product Code
15W LED Retrofit Light Engine	LLED-15	277018
15W LED LVPF Heavy Duty Light Fixture	LVPF-LED	277074
15W LED LVPE Utility Light Fixture	LVPE-LED	277075

Ceiling Mount with Standard Clear Glass Globe

Description	Part Number	Product Code
150W Incandescent	LVPF150C	077225
150W Incandescent Less Guard	LVPF150LG	077237
26W Compact Fluorescent	LVPL26C	077170
18W Compact Fluorescent	LVPL18C	077210
13W Compact Fluorescent	LVPL13C	077122
9W Compact Fluorescent	LVPL9C	077121
7W Compact Fluorescent	LVPL7C	077120

Ceiling Mount with Clear Polycarbonate Globe (no guard)

26W Compact Fluorescent	LVPL26PCC	077176
18W Compact Fluorescent	LVPL18PCC	077211
13W Compact Fluorescent	LVPL13C	077165
9W Compact Fluorescent	LVPL9PCC	077155
7W Compact Fluorescent	LVPL7PCC	077145

Pendant Mount with Standard Clear Glass Globe

Description	Part Number	Product Code
150W Incandescent	LPMF150C	077231
26W Compact Fluorescent	LPPL26C	077184
18W Compact Fluorescent	LPPL18C	077212
13W Compact Fluorescent	LPPL13C	077185
9W Compact Fluorescent	LPPL9C	077183
7W Compact Fluorescent	LPPL7C	077182

Pendant Mount with Clear Polycarbonate Globe (no guard)

26W Compact Fluorescent	LPPL26PCC	077375
18W Compact Fluorescent	LPPL18PCC	077273
13W Compact Fluorescent	LPPL13C	077365
9W Compact Fluorescent	LPPL9PCC	077355
7W Compact Fluorescent	LPPL7PCC	077345

Ceiling Utility Light Fixture 150 Watt Incandescent

Description	Part Number	Product Code
w/ Standard glass globe	LVPE150-10/15	077493
w/ Polycarbonate globe	LVPE150-PCC	077181
w/ Standard glass globe & guard		
Maximum 60W incandescent lamp with polycarbonate globe	LVPE150-10/15G	077402
w/ Heat resistant glass globe CLEAR	LVPE150HRC	077578
w/ Heat resistant glass globe RED	LVPE150HRR	077599
w/ Heat resistant glass globe BLUE	LVPE150HRB	077579
w/ Heat resistant glass globe GREEN	LVPE150HRG	077597
w/ Heat resistant glass globe AMBER	LVPE150HRA	077598
Clamp-on guard for LVPE	LVPUG150	077558

GLOBE OPTIONS

(For incandescent and fluorescent options only)

Standard Clear Glass Globes

Ideal for general purpose area lighting for either indoor or outdoor use.

Clear Polycarbonate Globes

Impact resistant globes for added protection in case of accidental contact

Coloured Heat-Resistant Glass Globes

Available in red, blue, green or amber – to transform the light to an indicator or warning light.

HAZARDOUS LOCATIONS (NON-LED ONLY)

Ceiling Mount with Heat Resistant Glass Globe

Description	Part Number	Product Code
150W Incandescent Clear	LVPF150HRC-HAZ	077414
150W Incandescent Red	LVPF150HRR-HAZ	077415
150W Incandescent Blue	LVPF150HRB-HAZ	077416
150W Incandescent Green	LVPF150HRG-HAZ	077417
150W Incandescent Amber	LVPF150HRA-HAZ	077494
26W Compact Fluorescent Clear	LVPL26HRC-HAZ	077377
26W Compact Fluorescent Red	LVPL26HRR-HAZ	077378
26W Compact Fluorescent Blue	LVPL26HRB-HAZ	077379
26W Compact Fluorescent Green	LVPL26HRG-HAZ	077399
26W Compact Fluorescent Amber	LVPL26HRA-HAZ	077400
18W Compact Fluorescent Clear	LVPL18HRC-HAZ	077347
18W Compact Fluorescent Red	LVPL18HRR-HAZ	077348
18W Compact Fluorescent Blue	LVPL18HRB-HAZ	077349
18W Compact Fluorescent Green	LVPL18HRG-HAZ	077353
18W Compact Fluorescent Amber	LVPL18HRA-HAZ	077354

Pendant Mount with Heat Resistant Glass Globe

Description	Part Number	Product Code
150W Incandescent Clear	LPMF150HRC-HAZ	077495
150W Incandescent Red	LPMF150HRR-HAZ	077496
26W Compact Fluorescent Clear	LPPL26HRC-HAZ	077407
26W Compact Fluorescent Red	LPPL26HRR-HAZ	077409
18W Compact Fluorescent Clear	LPPL18HRC-HAZ	077500
18W Compact Fluorescent Red	LPPL18HRR-HAZ	077498

Wall Mount Bracket (for WET and Hazardous Locations)

Description	Part Number	Product Code
Wall Mount bracket	LWB150	077233

For wall mount fixtures select and order the appropriate style (wattage and globe) ceiling mount fixture from above and add LWB150.

Sceptalight compact fluorescent light fixtures are supplied complete with lamp and ballast.



Clear Polycarbonate



Standard or Heat-Treated Clear Glass



Heat-Treated Blue Glass



Heat-Treated Red Glass

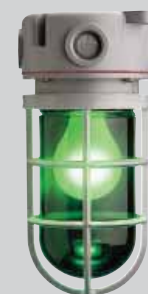

Heat-Treated Green Glass



Heat-Treated Amber Glass

SALES AND CUSTOMER SERVICE

Canadian Customers call IPEX Electrical Inc.

Toll free: (800) 473-9462

www.ipexna.com

About the IPEX Group of Companies

As leading suppliers of thermoplastic piping systems, the IPEX Group of Companies provides our customers with some of the largest and most comprehensive product lines. All IPEX products are backed by more than 50 years of experience. With state-of-the-art manufacturing facilities and distribution centers across North America, we have earned a reputation for product innovation, quality, end-user focus and performance.

Markets served by IPEX group products are:

- Electrical systems
- Telecommunications and utility piping systems
- PVC, CPVC, PP, PVDF, PE, ABS, and PEX pipe and fittings
- Industrial process piping systems
- Municipal pressure and gravity piping systems
- Plumbing and mechanical piping systems
- Electrofusion systems for gas and water
- Industrial, plumbing and electrical cements
- Irrigation systems

Sceptalight™ is manufactured by IPEX Electrical Inc.

Sceptalight™ is a trademark of IPEX Branding Inc.



This literature is published in good faith and is believed to be reliable. However, it does not represent and/or warrant in any manner the information and suggestions contained in this brochure. Data presented is the result of laboratory tests and field experience.

A policy of ongoing product improvement is maintained. This may result in modifications of features and/or specifications without notice.



IPEX
Committed to Excellence

BRELLFIP160801C
© 2016 IPEX EL0028C

